

KOOLMASTER[®] PP-32



ENVIRONMENTAL
MANAGEMENT
SYSTEM

CONTROLLER



SERIAL NUMBER: _____

DATE: _____

Read this guide carefully before using the controller.

NOTICE

Every effort has been made to ensure that this manual is complete, accurate and up-to-date. The information contained in it is however subject to change without notice due to further developments.

TABLE OF CONTENTS

Page

1. PRECAUTIONS	6
2. FEATURES	7
3. LOCATION OF THE CONTROLS	9
4. MOUNTING INSTRUCTIONS	11
4.1 CONNECTION	11
4.2 SETTING THE DIP SWITCHES	14
5. CONTROLLER SETUP	15
5.1 CURRENT CONDITIONS	15
5.2 CONTROLLER PROGRAMS	16
5.2.1 Selecting a Program	16
5.2.2 Selecting a Season	16
5.3 ADJUSTING THE ROOM SET POINT	18
5.4 MINIMUM VENTILATION	19
5.4.1 Adjusting Minimum Ventilation's On-Time	19
5.4.2 Adjusting Minimum Ventilation's Cycle Time	20
5.5 INLET / VENT DOOR SETTINGS	21
5.5.1 Inlet Settings (Potentiometer Feedback from Inlets)	21
5.5.1.1 Setting DWR-F-1A's ID numbers	21
5.5.1.2 Adjusting the Air Inlet Compensation	22
5.5.2 Vent Door Settings	23
5.5.2.1 Adjusting Static Pressure Set Points	26
5.5.2.2 Adjusting Vent Doors Open / Close / Off Times	26
5.5.2.3 Adjusting Stage Level for the Closing of Vent Doors	28
5.5.2.4 2nd Group of Pressure Set Points: at Stage X	28
5.5.2.5 2nd Group of Pressure Set Points: at Outside T° X	29
5.6 TUNNEL CURTAIN	31
5.6.1 Adjusting Minimum Age for Tunnel Ventilation	34
5.6.2 Selecting the First Tunnel Stage	34
5.6.3 Adjusting Curtain's Operating Times	35
5.6.4 Adjusting Static Pressure Hi and Lo Set Points	36
5.6.5 Adjusting Curtain's Timer Cycle	36
5.7 FAN STAGES SETTINGS	38
5.7.1 Adjusting Fan Stages' Start/Stop Temperatures	39
5.7.2 Adjusting Fans Stages' Timer	39
5.8 HEATER SETTINGS	41

5.9 AUXILIARY OUTPUTS	42
5.10 ANIMAL AGE	44
5.11 CLOCK OUTPUTS	45
5.11.1 Adjusting Clock Output Start and Stop Times	46
5.11.2 Adjusting Starting Day of Clock Programs	47
5.12 HISTORY	48
5.12.1 Resetting Histories	48
5.12.2 Average Temperature History	48
5.12.3 Individual Temperature Sensors History	49
5.12.4 Outside Temperature Sensor History	49
5.12.5 Relative Humidity History	49
5.12.6 Water Consumption History	50
5.12.7 Heater Run Time History	50
5.13 ALARM SETTINGS	52
5.13.1 Alarm Log	52
5.13.2 Setting Alarm Limits	53
5.13.2.1 <i>Adjusting Hi/ Lo Temperature Alarms</i>	54
5.13.2.2 <i>Adjusting Critical Temperature</i>	55
5.13.2.3 <i>Adjusting the Outside Temperature Influence</i>	55
5.13.2.4 <i>Adjusting Static Pressure Alarms</i>	56
5.13.3 Resetting the Alarm Log	58
5.14 INSTALLATION	59
5.14.1 Step-by-Step Installation Guide	59
5.14.2 Password Settings	61
5.14.3 Installation Setup	63
5.14.4 Sensor Assignment	66
5.14.4.1 <i>Assigning Sensors to the Room T° and Fan Stages</i>	66
5.14.4.2 <i>Assigning Sensors to Heater Stages</i>	67
5.14.4.3 <i>Assigning Sensors to Air Inlets</i>	67
5.14.4.4 <i>Assigning Sensors to Auxiliary Outputs</i>	68
5.14.5 Setting Time and Date	70
5.14.6 Relay Assignment	70
5.14.6.1 <i>Assigning Fan Stages' Relays</i>	72
5.14.6.2 <i>Assigning Heater Stages' Relays</i>	73
5.14.6.3 <i>Assigning Relays to Vent Doors</i>	73
5.14.6.4 <i>Assigning Relays to the Tunnel Curtain</i>	74
5.14.6.5 <i>Assigning Relays to Clock Outputs</i>	75
5.14.6.6 <i>Assigning Relays to Auxiliary Outputs</i>	75
5.14.6.7 <i>Assigning Relays for the Lo Static Pressure Alarm</i>	76
5.14.7 Calibrating the Water Counter	77

5.15 ADVANCED SETTINGS	78
5.15.1 Setting the Temperature Curve	78
5.15.2 Setting the Minimum Ventilation Curve	80
5.15.3 Humidity Control	82
5.15.3.1 <i>Adjusting Relative Humidity Set Point</i>	82
5.15.3.2 <i>RH Compensation on Minimum Ventilation</i>	83
5.15.3.3 <i>Adjusting Mist or Kool-Cel Shutoff</i>	84
5.15.3.4 <i>RH Compensation on Heaters' On-Time</i>	84
5.15.4 Calibrating Sensors	86
5.15.4.1 <i>Calibrating Room and Outside T° Sensors</i>	86
5.15.4.2 <i>Calibrating the Relative Humidity Sensor</i>	86
5.15.4.3 <i>Calibrating the Static Pressure Level</i>	87
6. TECHNICAL SPECIFICATIONS	89
7. FACTORY SETTINGS	90
8. USING THE MEMORY STICK	91
8.1 LOAD A CONFIGURATION INTO THE CONTROLLER	91
8.2 SAVE A CONFIGURATION INTO THE MEMORY STICK	92
9. INSTALLATION REPORT	93
10. INDEX	98

1. PRECAUTIONS

We strongly recommend installing supplementary natural ventilation as well as a backup thermostat on at least one cooling stage (refer to the wiring diagram enclosed with this user's manual to connect the thermostat).

Although fuses at the input and outputs of the controller protect its circuits in case of an overload or overvoltage, we recommend installing an additional protection device on the controller's supply circuit.

The room temperature where the controller is located **MUST ALWAYS REMAIN BETWEEN 32° F AND 104° F (0° C TO 40° C).**

To avoid exposing the controller to harmful gases or excessive humidity, it is preferable to install it in a corridor.

DO NOT SPRAY WATER ON THE CONTROLLER

FOR CUSTOMER USE

Enter the serial number located on the side of the controller below for future reference.

Model number: **PP-32**

Serial number: _____

2. FEATURES

The PP-32 is an electronic device used for environmental control in livestock buildings. It allows the user to maintain a specified target temperature by controlling the operation of ventilation and heating equipment. Eight heater stages, 16 fan stages, a tunnel curtain, 2 auxiliary outputs, vent doors and 4 clock outputs can be controlled. Fan stages can be configured to activate cooling systems in timer mode. In all, the PP-32 provides up to 32 relay outputs. In addition, up to 12 DWR-F-1A air inlet controllers can be connected to the PP-32.

The main features of the PP-32 are as follows:

LCD DISPLAY

An LCD display provides an efficient interface for displaying, monitoring and adjusting parameter values.

MINIMUM VENTILATION CYCLE

When ventilation is not required for reducing room temperature, on-off fan outputs can be operated either continuously or intermittently to reduce the level of humidity and supply oxygen to the room.

TEMPERATURE AND MINIMUM VENTILATION CURVES

The controller can automatically change the temperature set point and the minimum ventilation's On-Time over a given period of time in accordance with the user's requirements.

AVERAGE TEMPERATURE READINGS RECORDED FOR THE PAST 60 DAYS

The average temperature readings are logged into the controller's history for the past 60 days.

INDIVIDUAL SENSOR READINGS RECORDED FOR THE PAST 10 DAYS

The minimum and maximum readings of each sensor (temperature & humidity sensors) are logged into the controller's history for the past 10 days.

WATER AND HEATER MONITORING

A pulse input is provided to monitor the water consumption. Heater run times are also logged into an history. These values are recorded for the current day and for the previous 60 days.

ALARM MANAGEMENT

Alarms are provided for high-low temperatures, defective sensors and other system failures. The controller keeps in memory the 10 most recent alarms.

EIGHT INDEPENDENT TEMPERATURE SENSOR INPUTS

Up to eight temperature sensors can be connected to the controller in order to obtain a more accurate reading of the average room temperature and a faster reaction time. Sensors may be assigned to each heater output or to auxiliary outputs. Auxiliary outputs can be used to operate various devices such as heating units or stir fans for instance.

OUTSIDE TEMPERATURE SENSOR

HUMIDITY COMPENSATION

Three mechanisms can be used to compensate for a high humidity level:

1. Fans' On-Time, in minimum vent. cycles, can automatically be increased.
2. Kool-Cel or mist units can be shutoff.
3. Heaters can be activated in timer mode.

STATIC PRESSURE & VENT DOORS & TUNNEL CURTAIN CONTROL

A static pressure input is provided to control static pressure by opening and closing the vent doors and/or tunnel curtain.

CONTROL OF AIR INLET MOVEMENT

If the PP-32 is used in combination with one or more DWR-F-1A controllers, the movement of air inlets can be coordinated with the operation of the fans using a potentiometer located on the panel drive. This allows the air inlets to be adjusted correctly, without the influence of uncontrollable factors such as wind or air from adjoining rooms.

PASSWORD PROTECTION

A password can be enabled to restrict access to the controller setup functions.

BACKUP BATTERY

A backup battery allows the unit to keep time in case of a power failure.

OVERLOAD AND OVERVOLTAGE PROTECTION

Resettable fuses are provided at low-voltage inputs and outputs of the controller to protect its circuitry in the case of an overload or overvoltage.

COMPUTER CONTROL

The controller can be connected to a computer, thus making it possible to centralize the management of information and diversify control strategies.

TEST MODE

A test mode allows you to simulate temperature changes and verify controller performance, as well as manually activate each output sequentially.

3. LOCATION OF THE CONTROLS

Front Panel

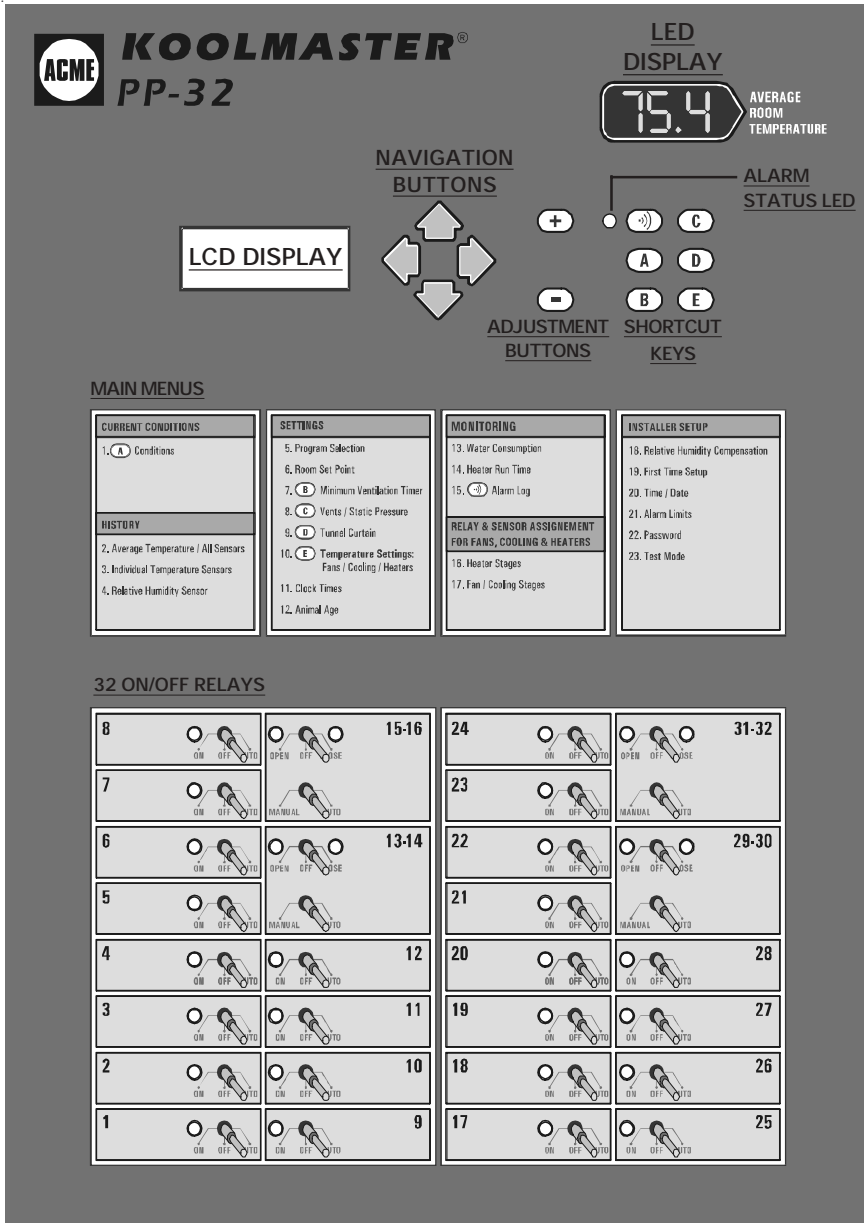

LCD Display: The LCD display gives the current readings and parameters to be adjusted when you select a function. When the parameters for a given function cannot all be presented at once on the display, arrows are displayed on the right handside to indicate that additional parameters can be displayed using the arrow keys.

After 5 minutes of inactivity, the display returns to the **CURRENT CONDITIONS** display.







Led Display: This display shows the current average room temperature.

Navigation buttons (Arrow Keys): The up and down-arrow keys are used to scroll within a function menu. The right-arrow key is used to select a menu option. The left arrow key is used to return to the previous menu display.

Adjustment Buttons: These two push-buttons allow the user to adjust the value of a parameter that is shown on the display.

Adjusting a Parameter: A parameter can be adjusted when it is flashing on the LCD display. Use the adjustment buttons to change the value of a parameter. Pressing (+) increases the value, pressing (-) decreases the value.

Shortcut Keys: These 6 buttons allow the user to step quickly to the special predefined functions on the display.

Shortcut Keys	Destination
	Alarm Log
	Current Conditions
	Minimum Ventilation Timer
	Vent Doors / Static Pressure Settings
	Tunnel Curtain Settings
	Temperature Settings (Fans / Cooling Stages)

4. MOUNTING INSTRUCTIONS

Fasten the four metal brackets on the mounting holes located behind the controller using the four screws included with the controller. Mount the enclosure on the wall using four other screws. Make sure the electrical knockouts are at the bottom of the enclosure in order to prevent water from entering the controller. The enclosure must be mounted in a location that will allow the cover to be completely opened right up against the wall. Push on the locking devices to open the enclosure as illustrated.

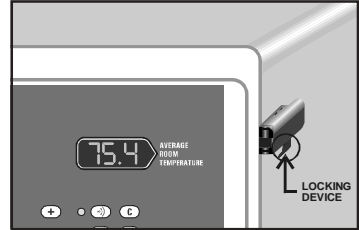

4.1 CONNECTION

To connect the controller, refer to the wiring diagram enclosed with this user's manual. Use the electrical knockouts provided at the bottom of the enclosure. Do not make additional holes in the enclosure, particularly on the side of the enclosure when using a computer communications module.

1. SENSOR INPUTS

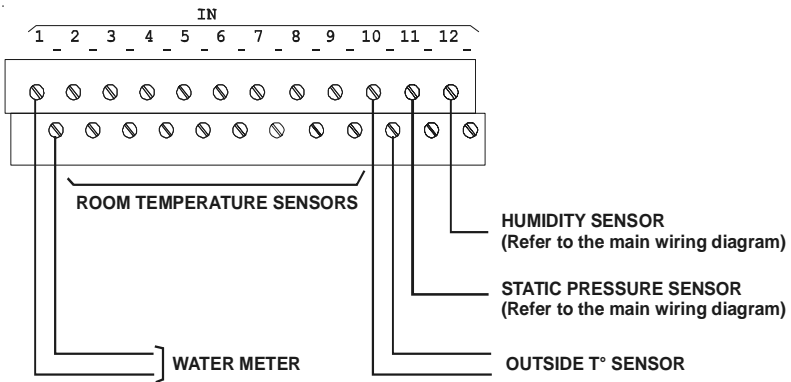

ALL WIRING MUST BE DONE BY AN AUTHORIZED ELECTRICIAN AND MUST COMPLY WITH APPLICABLE CODES, LAWS AND REGULATIONS. BE SURE POWER IS OFF BEFORE DOING ANY WIRING TO AVOID ELECTRICAL SHOCKS AND EQUIPMENT DAMAGE.



Sensors operate at low voltage and are isolated from the supply. Be sure that sensor cables remain isolated from all high voltage sources. In particular, do not route the sensor cables through the same electrical knockout as other cables. Do not connect the shield from the sensor cable to a terminal or a ground.

Extending a sensor: Each sensor can be extended up to 500 feet (150 meters). To extend a sensor:

- Use a shielded cable of outside diameter between 0.245 and 0.260 in (6.22 and 6.60 mm) (the cable dimensions should not be under 18 AWG) to ensure the cable entry is liquid tight. **Do not ground the shielding.**
- It is preferable to solder the cable joint to ensure a proper contact between the two cables.

CAUTION: Do not run sensor cables next to other power cables. When crossing over other cables, cross at 90°.

Defective temperature sensors: An alarm is generated when a defective sensor is detected. The defective temperature sensors are identified in the "15. Alarm Log" menu. Press the  key to directly access this menu.

2. ALARMS

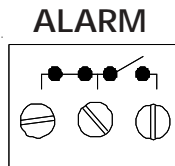

There are two types of alarms on the market. One type activates when current is cut off at its input, whereas the other activates when current is supplied at its input. For an alarm of the first type, use the NC 

terminal as shown on the wiring diagram. For an alarm of the second type, use the NO  terminal.

3. DWR-F-1A COMMUNICATION HOOKUP

If DWR-F-1A air inlet controllers are connected to the PP-32, use id numbers within the range 4-15. Id numbers 1,2 and 3 are reserved for another purpose. Refer to section 5.5.1.1 to set the proper ID numbers.

4.2 SETTING THE DIP SWITCHES

The PP-32 has 12 DIP switches (only the first 7 are used) which determine how the controller works. These switches are located on the board inside the top cover.

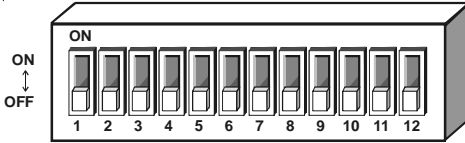

To change the position of a DIP switch, use a small screwdriver or similar object to move the switch to the desired position.



Pay attention when setting DIP switches. Since they are very close to each other, it is easy to switch 2 switches at the same time.



When the controller is shipped, all DIP switches are set to the OFF position.

ALWAYS close the controller before applying power to it.

DIP SWITCH TABLE		
Switch #	OFF	ON
1	FAHRENHEIT DEGREES	CELSIUS DEGREES
2	AM / PM MODE	24 HOURS MODE
3	GALLONS	LITERS
4	INCHES OF WATER	PASCALS
5	KOOL CELL OR MIST RH COMPENSATION DISABLE	KOOL CELL OR MIST RH COMPENSATION ENABLE
6	HEATER RH COMPENSATION DISABLE	HEATER RH COMPENSATION ENABLE
7	MINIMUM VENTILATION RH COMPENSATION DISABLE	MINIMUM VENTILATION RH COMPENSATION ENABLE
8	NOT USED	
9	NOT USED	
10	NOT USED	
11	NOT USED	
12	NOT USED	

5. CONTROLLER SETUP

5.1 CURRENT CONDITIONS

The current conditions menu gives a quick view of the actual conditions in the barn. Press **(A)** to step directly to this menu.

Room Set Point: this is the target temperature in the barn.

Average Temperature: shows the average temperature in the barn.

Static Pressure: current static pressure in the barn.

Fan Stage: shows which fan stage is currently active.

Program: shows the selected program.

Fan On-Time sec: fans' on-time in minimum ventilation.

Sensor 1-8: actual reading of each temperature sensor.

Outside: actual outside temperature reading.

R. Humidity: current humidity level in the room.

Room Set Point	80.0
Average Temp	79.2
Static Pressure	0.01
Fan Stage:	Min.V
Program:	(a)
Fan On Time sec	30
Sensor 1:	79.3
Sensor 2:	79.1
Outside:	65.9
R. Humidity	74

5.2 CONTROLLER PROGRAMS

The controller allows to use up to 4 separate programs to control the room temperature. It then becomes possible to activate a specific program, that uses particular fan settings, in accordance with the animal age for instance.

Relays that are activated on fan stages 1-4 vary depending on the chosen program: the first 4 fan stages use separate relay assignment settings for each program. This allows to activate a greater number of fans as the occupied space in the barn increases. Fan stage's sensor assignment must also be set separately for each program in use.

5.2.1 Selecting a Program

- Use the navigation buttons to select "5. Program Select" from the main menu then press the right-arrow key. The program that is currently in use is flashes on the display.

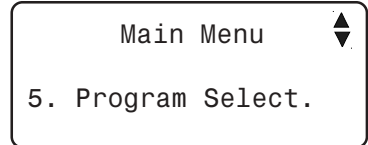

- Use the adjustment buttons to select the proper program (a, b, c or d). Only the programs that have been enabled during the installation can be selected (see sec. 5.14.3). Press the left-arrow key to exit this menu.

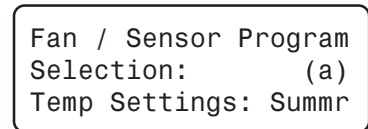

5.2.2 Selecting a Season

The start and stop temperatures of heating and ventilation stages can be set separately for summer and winter seasons. The season change is signalled by the user as follows:

- Use the navigation buttons to select "5. Program Select" from the main menu then press the right-arrow key. The program that is currently in use is flashes on the display.
- Press the down-arrow key to select the "Temp Settings" display.

- Use the adjustment buttons to select the proper season (winter/summer). The start and stop temperatures of heating and ventilation stages that are associated with this seasons will be used.
- Press the left-arrow key to exit this menu.

Fan / Sensor Program
Selection: (a)
Temp Settings: Summr

5.3 ADJUSTING THE ROOM SET POINT

The room set point is the target room temperature. It can be adjusted between 32° F and 120° F (0° C and 48.9° C). Note that the temperature curve must be turned off to adjust this value.

The set point can quickly be accessed by pressing the **(E)** shortcut key (note that the set point will not be accessible this way if the temperature curve is turned on, see below to deactivate the temperature curve).

- Select the "6.Room Set Point"** function from the main menu using the navigation buttons then press the right-arrow key. The current set point is displayed, as well as the on/off state of the temperature curve.

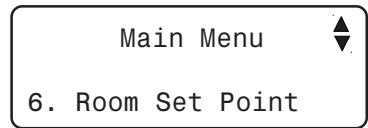

- If the temperature curve is OFF**, the set point flashes on the display. Use the adjustment buttons to adjust the room set point to the desired value.

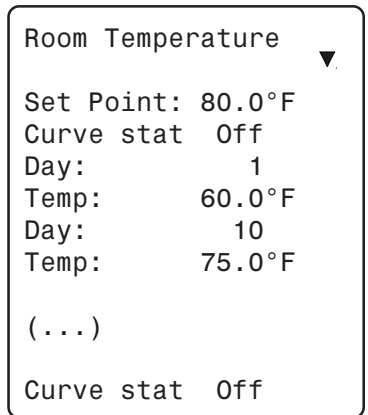

- If the temperature curve is ON**, the set point, as determined by the temperature curve, is displayed. Press the down-arrow key and scroll the menu until "**Curve stat**" status flashes on the display. Press **(-)** to turn off the temperature curve then follow the procedure above to adjust the set point.

5.4 MINIMUM VENTILATION

PRINCIPLE OF OPERATION

When the room temperature is below the set point, fans can operate according to a timer. The minimum ventilation cycles runs stage 1 fans according to a timer as shown below. Running fans even though ventilation is not required for reducing the room temperature is useful to reduce the humidity level and supply oxygen to the room. It also prevents the fans from freezing in winter.

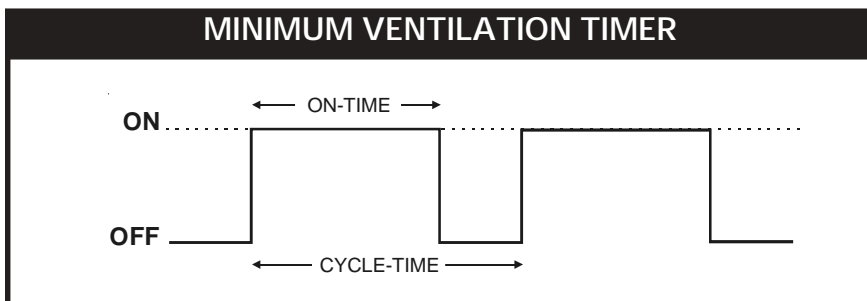

In addition, fans' On-Time, in minimum ventilation, can automatically be adjusted over time by using a curve. Refer to section 5.15.2 for further information on the minimum ventilation curve.



Note that the minimum ventilation curve must be **TURNED OFF** in order to adjust minimum ventilation settings.

5.4.1 Adjusting Minimum Ventilation's On-Time

Fans' On-Time, in the minimum ventilation cycle, can be adjusted from 0 to 900 seconds (15 minutes), in increments of 5 seconds. Note that the On-Time cannot be greater than the cycle time. If vent doors are used, the On-Time is limited by the vent doors' pre-opening delay (see sec. 5.14.3).

- Select "**7.Min. Ventilation**" from the main menu using the navigation buttons then press the right-arrow key.

Min ventilation	▲▼
On Time:	30sec
Curve stat	Off

- Use the arrow keys to select the "**1. On Time/Curve**" function. Press the right-arrow key. The fans' On- Time, in minimum ventilation, is displayed, as well as the status of the minimum ventilation curve.
- **If the curve is OFF**, the On-Time value flashes on the display. Use the adjustment buttons to adjust minimum ventilation's On- Time to the desired value then press the left-arrow key to exit this menu.

Min ventilation ▲▼

Curve stat Off
- **If the curve is ON**, press the down-arrow key to scroll all ten points of the curve. The curve status flashes on the display. Press  to turn off the minimum ventilation curve then follow the procedure above to adjust the set point.

5.4.2 Adjusting Minimum Ventilation's Cycle Time

Fans' Cycle-Time, in minimum ventilation, can be adjusted from 0 to 900 seconds (15 minutes), in increments of 5 seconds. If vent doors are used, the Cycle-Time is limited by the vent doors' pre-opening delay : it must be set at a greater value than twice the **pre-opening delay** (see sec. 5.14.3).

- Select "**7.Min. Ventilation**" from the main menu using the navigation buttons then press the right-arrow key.

Min Ventilation

Cycle Time 300sec
- Use the arrow keys to select the "**2. Cycle Time**" function. Press the right-arrow key. The current cycle time flashes on the display.
- Use the adjustment buttons to adjust the Cycle-Time to the desired value then press the left-arrow key to exit this menu.

5.5 INLET / VENT DOOR SETTINGS

The PP-32 controller can operate the air inlets / vent doors in two different ways:

1. Inlets' positions can be determined by using a potentiometer feedback controller (DWR-F-1A). Refer to the installation setup section to enable DWR-F-1A modules. Note that the static pressure sensor must be deactivated in order to activate the air inlets (see sec. 5.15.3).
2. Inlets' positions can be determined by the static pressure level in the barn. In this case, a static pressure sensor is required and must be activated during the installation setup (see sec. 5.15.3). The term "**Vent Door**" is used to refer to an air inlet that is controlled by the static pressure.

5.5.1 Inlet Settings (Potentiometer Feedback from Inlets)

If air inlets operate according to potentiometer feedback modules (DWR-F-1A), the PP-32 controller adjusts the air inlets opening according to ventilation stages. As the temperature increases and new stages are activated, the inlet is opened or closed accordingly. The air inlet position is directly related to these ventilation stages. Refer to the DWR-F-1A instruction manual to program inlet openings.

In addition, a compensation can be activated to ensure the uniformity in room temperature: air inlet positions are automatically adjusted when the reading of the sensors that are associated with the air inlet differs from the average room temperature.

5.5.1.1 Setting DWR-F-1A's ID numbers

ID numbers must be assigned to each DWR-F-1A modules. This allows to establish the communication with the PP-32 control and the external modules. The following table gives the proper ID numbers for each DWR-F-1A module.

PP-32

Note that the reference numbers that are used by the PP-32 DO NOT correspond to the ID numbers that used by the DWR-F-1A modules because #1, 2 and 3 are reserved for other purpose.

PP-32 Reference #	DWR-F-1A id #
1	4
2	5
...	...
12	15

5.5.1.2 Adjusting the Air Inlet Compensation

The compensation is expressed as a percentage per degree difference between the average controller's temperature and the average temperature of sensors that are assigned to the inlet. It determines by how much the inlet must open or close to help reduce the temperature differences in the building. For each degree above or below the average temperature, the inlet will open or close using the compensation value assigned by the user. For example, if the compensation value is set to 5%/°F and the inlet's sensors read 3°F above the average controller temperature, the inlet will open of 15% to help decrease the temperature in that zone.

The compensation can be adjusted from 0 to 10% of inlets' opening or to "Off" to deactivate this function.

- Select "**8.Inlet Settings**" from the main menu using the navigation buttons then press the right-arrow key. Note that this menu is only available if the static pressure sensor is disabled and if inlets have been activated (see sec. 5.15.3).

- Press the right-arrow key once again to select "**1.Inlet Comp**" menu. The compensation value of each air inlet is displayed.

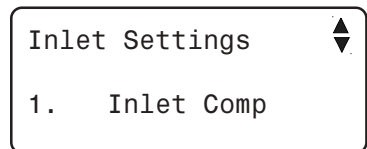

- Use the up or down-arrow key to select the desired inlet.

- Use the adjustment buttons to set the compensation to the proper value. Press the left-arrow key to exit this menu.

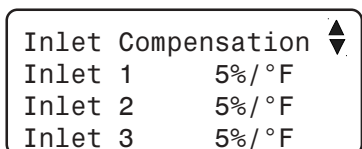

5.5.2 Vent Door Settings

If a static pressure sensor is used, the PP-32 can control the static pressure in the room by opening and closing vent doors. When the pressure drops below the low pressure set point, the vent doors close according to a timer. Likewise, when the static pressure increases above the high pressure set point, the vent doors open according to a timer. It is also possible to define a stage level above which the vent doors will always remain closed. Refer to sec. 5.15.3 to activate the static pressure sensor.

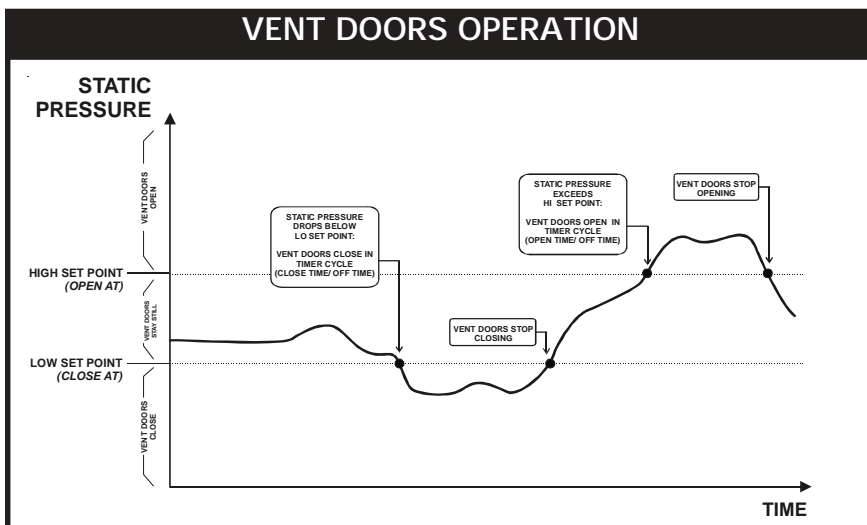

In minimum ventilation, the vent doors open during the pre-opening delay before fans start running. The same delay is used to close the vent doors when the stage 1 fans return to a stop.

Static Pressure Alarm: alarms can be set off if the static pressure remains below or exceeds a certain level for a too long period of time. In this case, a delay is set in order to activate the alarm: the alarm condition must be maintained during this delay before the alarm is set off. Refer to section 5.13.2 to set the static pressure alarm settings.

GROUPS OF STATIC PRESSURE SET POINTS :

Two groups of static pressure set points can be defined. HI and LO static pressure set points #2 start being used either when a certain ventilation stage is reached or when the outside temperature decreases below a user-define value. The following graphs sum both cases:

1. Static pressure set points' transition according to ventilation stages:

Example: when the start temperature of stage 5 is reached, the vent doors start operating according to the second group of static pressure set points. The first group of set points is being used once again when the room temperature drops below the stage 5 stop temperature.

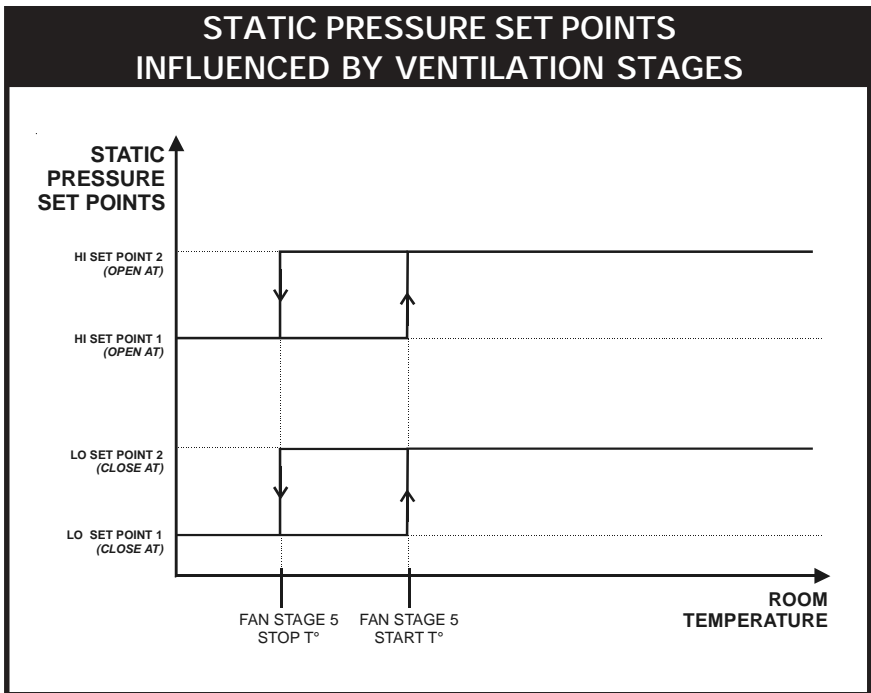

Refer to the installation setup section to activate the second group of static pressure set points (see sec. 5.14.3).

2. Static pressure set points' transition according to the outside T° :

Example: When the outside temperature drops below the "outside temperature influence" value, a transition between the two set point groups starts. When the outside temperature decreases 5° F further than the user-defined value, the second group of set points is used.

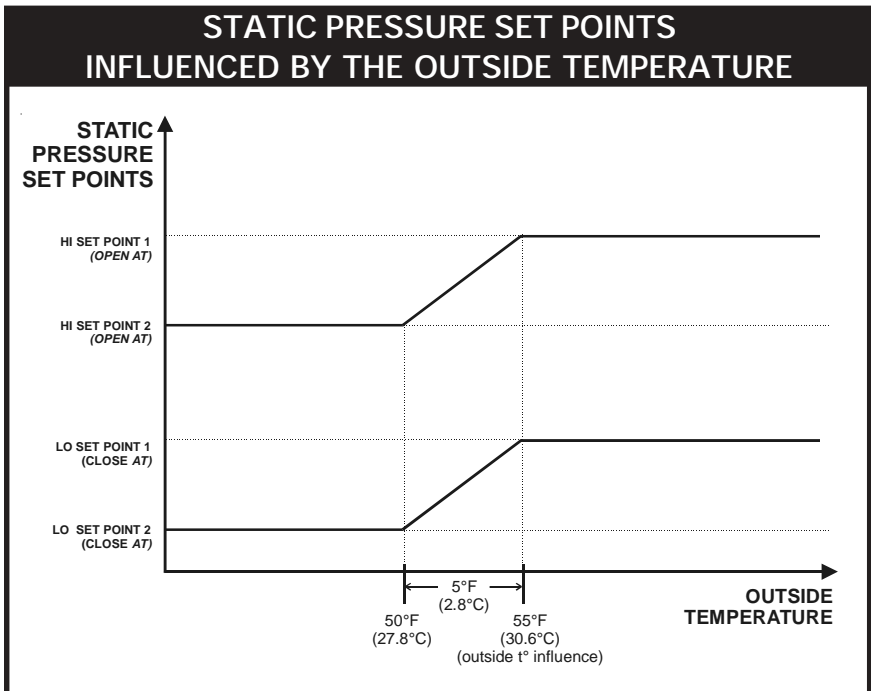

Refer to the installation setup section to activate the second group of static pressure set points (see sec. 5.14.3).

5.5.2.1 Adjusting Static Pressure Set Points

When the high pressure set point is reached (*Open at*), the controller opens the vent doors according to a timer cycle. When the low pressure set point is reached (*Close at*), the controller closes the vent doors according to the another timer. The pressure set points can be adjusted from 0 to 0.2 inches of water (0 to 50Pa).

- Select "**8.Vents/Static P**" from the main menu using the navigation buttons then press the right-arrow key. Note that this menu is only available if the static pressure sensor has been enabled during the installation setup (see sec 5.14.3).
- Press the right-arrow key to select the "**1.Set Points**" menu.
- Press the down-arrow key once, the LO static pressure set point is selected (*Close At*).

Vents/Static Press	▲▼
Cal. SP	.000"WC
Close At:	.070"WC
Open At:	.090"WC
- Use the adjustment buttons to adjust the low static pressure set point (*Close At*) to the desired value then press the down-arrow key. The hi static pressure set point (*Open At*) is selected.
- Use the adjustment buttons to adjust the hi static pressure set point (*Open At*) to the desired value.

5.5.2.2 Adjusting Vent Doors Open / Close / Off Times

When the static pressure level in the room exceeds the hi or low set points, the vent doors start opening or closing according to a cycle, as explained below:

Open Time: when the static pressure exceeds the Hi pressure set point, the vent doors open during this delay. The open time ranges from 0 to 900 seconds.

Close Time: when the static pressure drops below the Lo pressure set point, the vent doors close during this delay. The close time ranges from 0 to 900 seconds.

Off Time: once the vent doors have opened or closed (depending on the situation), they then stop operating during the Off time delay. The Off Time delay ranges from 0 to 900 seconds.

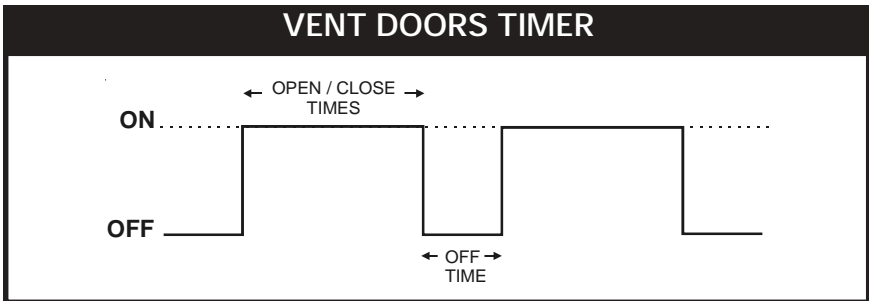

If the pressure has not reached the desired value after the Off Time, the cycle starts again, up until the pressure goes back into the normal range.

- Select **"8.Vents/Static P"** from the main menu using the navigation buttons then press the right-arrow key. Note that this menu is only available if the static pressure sensor has been enabled during the installation setup (see sec 5.14.3).
- Press the right-arrow key to select the **"1.Set Points"** menu.
- Press the down-arrow key in order to select the Open Time then use the adjustment buttons to set the opening time to the desired value.

Open Time	30sec
Close Time	30sec
Off Time	60sec
- Press the down-arrow key. The Close Time flashes on the display. Use the adjustment buttons to set the Close Time to the desired value.
- Press the down-arrow key once again. The Off Time flashes on the display. Use the adjustment buttons to set the Off Time to the desired value.

5.5.2.3 Adjusting Stage Level for the Closing of Vent Doors

When the stage defined by this parameter is reached, the vent doors start to close continuously until they are completely closed, no matter what the static pressure is. This feature is usefull for closing vent doors when a tunnel ventilation stage starts. Select "None" to deactivate this function.

- Select "**8.Vents/Static P**" from the main menu using the navigation buttons then press the right-arrow key. Note that this menu is only available if the static pressure sensor has been enabled during the installation setup (see sec 5.14.3).

- Press the right-arrow key to select the "**1.Set Points**" menu.

- Press the down-arrow key in order to select "**Close Vent Door At Stage**" menu on the display.

Close Time	30sec
Off Time	60sec
Close Vent Door At Stage	5

- Use the adjustment buttons to select the fan stage above which the vent doors will be closed.

5.5.2.4 2nd Group of Pressure Set Points: at Stage X

The following procedure shows how to select the fan stage above which the second group of static pressure set points starts being used. It also explains how to adjust Hi and Lo static pressure set points #2 (*Open At and Close At*). Refer to sec.5.14.3 to activate this function.

- Select the "**8.Vents/Static P**" from the main menu using the navigation buttons then press the right-arrow key. Note that this menu is only available if the static pressure sensor has been enabled during the installation setup (see sec 5.14.3).

- Press the right-arrow key to select the "**1.Set Points**" menu.

- Press the down-arrow key in order to select "**Static Settings 2 At Stage**" display. This menu is only displayed if the 2nd group of static pressure set points has been enabled during the installation (see sec. 5.14.3).

Static Settings 2	
At Stage	10
Close At:	.050"WC
Open At:	.080"WC

- Use the adjustment buttons to select the fan stage above which the second group of static pressure set points starts being used.
- Press the down-arrow key once, the LO static pressure set point #2 is selected (*Close At*).
- Use the adjustment buttons to adjust the 2nd low static pressure set point (*Close At*) to the desired value then press the down-arrow key. The HI static pressure set point #2 (*Open At*) is selected.
- Use the adjustment buttons to adjust the 2nd HI static pressure set point (*Open At*) to the desired value.
- Press the left-arrow key to exit this menu.

5.5.2.5 2nd Group of Pressure Set Points: at Outside T° X

The following procedure shows how to select the outside temperature below which the second group of static pressure set points starts being used. It also explains how to adjust the second group of Hi and Lo static pressure set points (*Open At and Close At*). Refer to sec.5.14.3 to activate this function.

- Select "**8.Vents/Static P**" from the main menu using the navigation buttons then press the right-arrow key. Note that this menu is only available if the static pressure sensor has been enabled during the installation setup (see sec 5.14.3).
- Press the right-arrow key to select the "**1.Set Points**" menu.
- Press the down-arrow key in order to the select "**Outside Temperature Influence**" display. Note that this menu only appears if the outside temperature has been enabled during the installation setup and if the 2nd Group of static pressure set points has been enabled (see sec 5.14.3).

Static Settings 2 Outside Temperature Influence: 50.0°F Close At: .070"WC Open At: .090"WC
--

PP-32

- Use the adjustment buttons to set the outside temperature below which the second group of static pressure set points start to be used.
- Press the down-arrow key once, the LO static pressure set point #2 (*Close At*) is selected .
- Use the adjustment buttons to adjust the 2nd low static pressure set point (*Close At*) to the desired value then press the down-arrow key. The HI static pressure set point #2 (*Open At*) is selected.
- Use the adjustment buttons to adjust the 2nd HI static pressure set point (*Open At*) to the desired value.
- Press the left-arrow key to exit this menu.

5.6 TUNNEL CURTAIN

The PP-32 allows you to control an endwall curtain for tunnel ventilation. The tunnel curtain is controlled either by the static pressure level in the barn or in timer mode, according to the room temperature. Select the proper mode (Timer or Static pressure) that is used to control the tunnel curtain in the installation setup (see sec 5.14.3).

In both modes, a minimum animal age is defined to avoid starting the tunnel ventilation mode when animals are too young.

Tunnel Curtain Controlled in Time Mode:

Every time a tunnel fan stage starts, the curtain opens according to the Open-Time related to this stage. A maximum running time is also set to limit the curtain's opening.

When the start temperature of the first tunnel stage is reached, the tunnel curtain opens during half of the opening time that is associated with this stage. When half of the opening time has elapsed tunnel fans are activated. When the next tunnel stage is reached, the tunnel curtain continues to open according to the opening time defined for that stage, etc. When the temperature decreases, the same sequence is executed in reverse order. The following diagram sums up the operation of the first two tunnel stages.

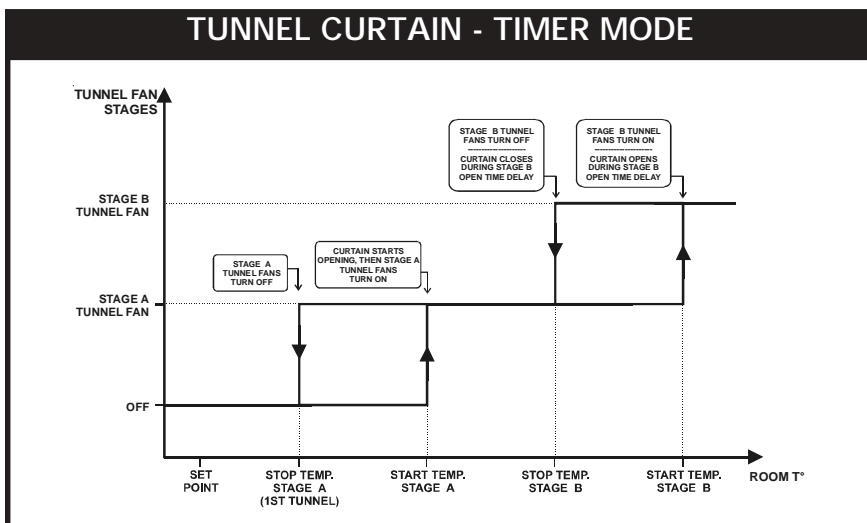

Tunnel Curtain Controlled by the Static Pressure:

When the pressure drops below the low pressure set point, the tunnel curtain closes according to a timer. Likewise, when the static pressure increases above the high pressure set point, the curtain opens according to another timer. The curtain only starts operating this way once the start temperature of the first tunnel stage has been reached.

When the curtain starts opening, it first opens during the pre-opening delay. Fans of the first tunnel stage are then activated.

The following diagram sums up the operation of the tunnel curtain controlled by the static pressure.

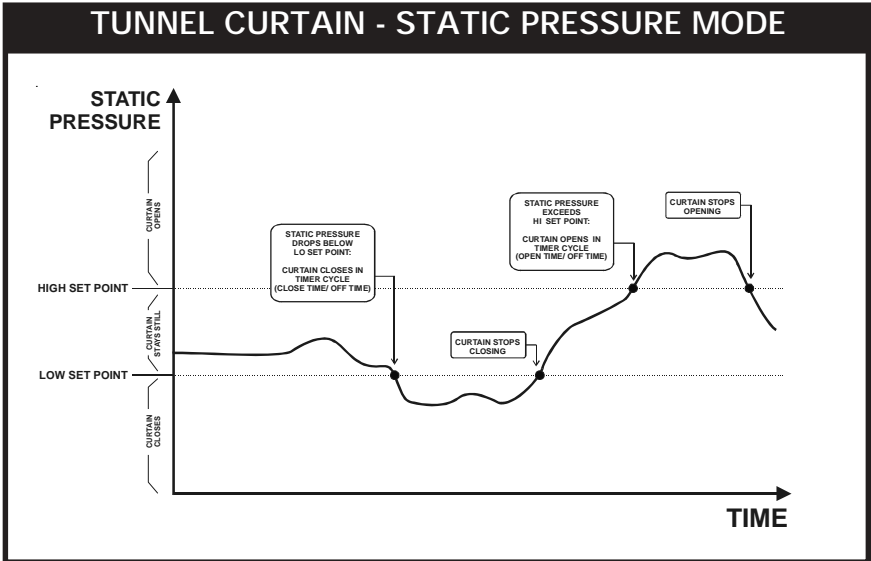

TRANSITION BETWEEN SIDEWALL AND TUNNEL VENTILATION MODES:

The following section describes the vent doors and curtain's behavior when the transition between sidewall ventilation (vent doors) and tunnel ventilation is being done. These steps are automatically performed by the controller.

VENT DOORS TO TUNNEL :

1. Vent doors stop operating;
2. The tunnel curtain opens during the Pre-Opening time;
3. Fans of the first tunnel stage turn on;
4. The tunnel curtain automatically adjusts the static pressure level, until it reaches *Lo Static Pressure Limit + 0.01"WC*;
5. Vent doors close until the static pressure level reaches *Hi Static Pressure Limit - 0.01"WC*;
6. Steps 4 and 5 are repeated until the vent doors run for over 30 seconds without reaching *Hi Static Pressure Limit - 0.01"WC*;

The house is now in tunnel mode.

TUNNEL TO VENT DOORS:

1. Tunnel fans are turned off when the temperature decreases and reaches the first non-tunnel stage;
2. The tunnel curtain automatically adjusts the static pressure level, until it reaches *Hi Static Pressure Limit - 0.01"WC*;
3. Vent doors open until the static pressure level reaches *Lo Static Pressure Limit + 0.01"WC*;
4. Steps 2 and 3 are repeated until the tunnel curtain runs for over 30 seconds without reaching a static pressure of *Hi Static Pressure Limit - 0.01"WC*;

The house is now in sidewall ventilation mode (vent doors).

5.6.1 Adjusting Minimum Age for Tunnel Ventilation

The minimum age is used to prevent tunnel ventilation from being used when the animals are too young. It ranges from 1 to 450 days. The tunnel curtain will never open until the animal age reaches this value.

- Select "**9.Tunnel Curtain**" from the main menu using the navigation buttons then press the right-arrow key. Note that this menu is only available if the tunnel curtain has been enabled during the installation setup (see sec 5.14.3).
- Press the right-arrow key once to select "**1.Set Points**" menu.

- Press the down-arrow key once to select "**Min. Animal Age**" then use the adjustment buttons to set the minimum animal age to the desired value.

Tunnel Curtain	▲▼
Tunnel Stage #	5
Min. Animal age	1

- Press the left-arrow key to exit this menu.

5.6.2 Selecting the First Tunnel Stage

The stage at which the tunnel curtain starts opening is related to a specific fan stage. All consecutive fan stages will then operate as tunnel fan stages. When the start temperature of the first tunnel fan stage is reached, the curtain starts to operate according to the static pressure or according to a timer (depending on the chosen mode).

- Select "**9.Tunnel Curtain**" from the main menu using the navigation buttons then press the right-arrow key. Note that this menu is only available if the tunnel curtain has been enabled during the installation setup (see sec 5.14.3).
- Press the right-arrow key once to select "**1.Set Points**" menu. The first tunnel stage # is displayed.

- Use the adjustment buttons to set the first tunnel stage.

Tunnel Curtain	▲▼
Tunnel Stage #	5
Min. Animal age	1

5.6.3 Adjusting Curtain's Operating Times

This function is only used if the curtain operates in timer mode.

The curtain's operating time is the time during which the curtain opens when a new tunnel fan stage is activated or closes when a tunnel fan stage is deactivated. This value needs to be adjusted for each tunnel fan stage. In addition, the user must set the maximum curtain's running time. The sum of all running times cannot exceed this value.

Operating times range from 0 seconds to 15 minutes, in increment of 5 seconds. Select "Off" if you do not want the curtain to open when the start temperature of a certain stage is reached.

- Select "**9.Tunnel Curtain**" from the main menu using the navigation buttons then press the right-arrow key. Note that this menu is only available if the tunnel curtain has been enabled during the installation setup (see sec 5.14.3).
- Press the right-arrow key once to select "**1.Set Points**" menu.
- Press the down-arrow key in order to select the "**Total Run Time**" function then use the adjustment buttons to set the curtain's maximum running time. This menu only appears if the tunnel curtain operates in timer mode (see sec 5.14.3).
- Press the down-arrow key once. The first tunnel fan stage is selected. Set the curtain's opening time for that stage. When the start temperature of this stage is reached, the curtain will open during this delay.
- Proceed in similar fashion to set all curtain running times for each tunnel stage below. Remember that the sum of all running times cannot exceed the "**Total Run Time**" value.

Tunnel Curtain	◆
Tunnel Stage #	5
Min. Animal age	1
Open/Clo Time mm:ss	
Total Run Time	2:00
Stage 5	0:30
Stage 6	0:30
Stage 7	0:30
Stage 8	0:30

5.6.4 Adjusting Static Pressure Hi and Lo Set Points

This function is only used if the curtain operates in static pressure mode.

When controlled by the static pressure, the curtain opens or closes according a timer cycle whenever the static pressure level exceeds the Hi or Lo static pressure set points. The Lo (*Close At*) and the Hi (*Open At*) set points can be adjusted from 0 to 0.2 inches of water (0 to 50Pa).

- Select "**9.Tunnel Curtain**" from the main menu using the navigation buttons then press the right-arrow key. Note that this menu is only available if the tunnel curtain has been enabled during the installation setup (see sec 5.14.3).
- Press the right-arrow key once to select "**1.Set Points**" menu.
- Press the down-arrow key in order to select the "**Close At**" value. This is the Lo static pressure set point. Note that this menu only appears if the tunnel curtain operates in static pressure mode (see sec 5.14.3).
- Use the adjustment buttons to adjust the Lo static pressure set point to the desired value.
- Press the down-arrow key in order to select the "**Open At**" value. This is the Hi static pressure set point.
- Use the adjustment buttons to adjust the Hi static pressure set point to the desired value. Press the left-arrow key to exit this menu.

Tunnel Curtain	▲▼
Tunnel Stage #	5
Min. Animal age	1
Close At:	.050"WC
Open At:	.080"WC

5.6.5 Adjusting Curtain's Timer Cycle

This function is only used if the curtain operates in static pressure mode.

When controlled by the static pressure, the curtain uses a timer cycle to close and to open. The tunnel curtain starts opening or closing according to this timer whenever the static pressure level exceeds high or low set points that have been defined above.

Open Time: when the static pressure exceeds the Hi pressure set point, the curtain opens during this delay. It ranges from 0 to 900 seconds.

Close Time: when the static pressure drops below the Lo pressure set point, the curtain closes during this delay. It ranges from 0 to 900 sec.

Off Time: once the curtain has opened or closed (depending on the situation) it then stops operating during this delay. The Off Time delay ranges from 0 to 900 seconds.

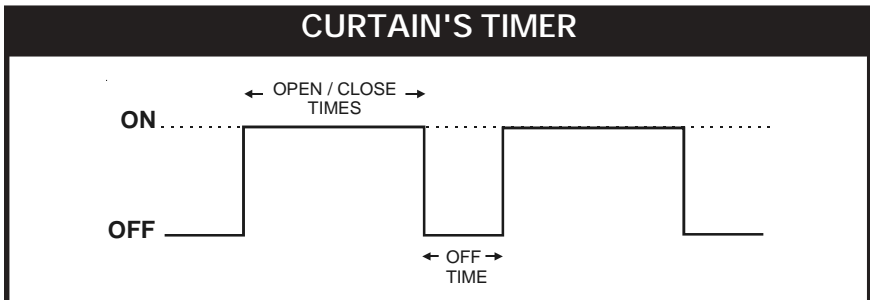

- Select **"9.Tunnel Curtain"** from the main menu using the navigation buttons then press the right-arrow key. Note that this menu is only available if the tunnel curtain has been enabled during the installation setup (see sec 5.14.3).
- Press the right-arrow key once to select **"1.Set Points"** menu.
- Press the down-arrow key in order to select the **"Open Time"** display. Use the adjustment buttons to adjust the Open Time. Note that this menu only appears if the curtain operates in static pressure mode (see sec 5.14.3).

Open At:	.080"WC
Open Time	60sec
Close Time	60sec
Off Time	10sec
- Press the down-arrow key in once. The Close Time is selected. Use the adjustment buttons to set the Close Time to the desired value.
- Press the down-arrow key in once. The Off Time is selected. Use the adjustment buttons to set the Off Time to the desired value.

5.7 FAN STAGES SETTINGS

The PP-32 controls up to 16 on-off fan stages. These stages operate in a sequence to increase the level of ventilation as the room temperature rises. Each stage can also activate relays in timer mode. The user defines a start and stop temperature for each stage. When the room reaches the start temperature, the stage is activated. When the room reaches the stop temperature, the stage is deactivated. The following diagram shows how fan stages operate.

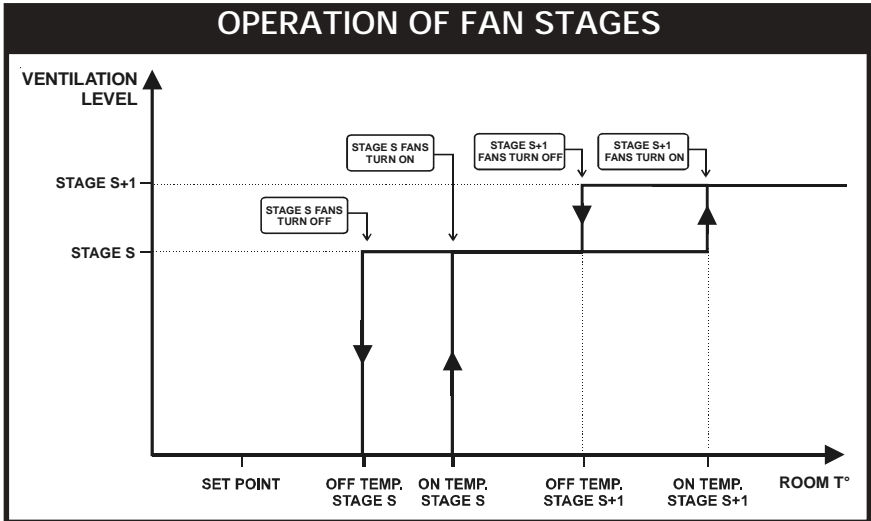

Start temperatures are defined with respect to the set point and with respect to each other. This means that when one of these values is adjusted, all the consecutive values are adjusted by the same amount. For example, if the set point is increased by 1°F, the start temperatures for all fan stages will be increased by the same amount. The minimum temperature difference between two start temperatures is 0.5°F.

Start and stop temperatures of all fan stages are set separately for the summer and winter seasons. Refer to sec. 5.2.2 to select the proper season.

The relay assignment for fan stages 1 to 4 differs depending on the selected program. Refer to section 5.2 for further information on the controller's programs and to section 5.14.6 to assign fan stage relays.

5.7.1 Adjusting Fan Stages' Start/Stop Temperatures

The minimum temperature difference between two consecutive start temperatures is 0.5°F (0.3°C). The stop temperature of a fan stage must always be lower than its start temperature.



Make sure the right season is selected before making any changes in start/stop temperatures of fan stages. The selected season appears beside the start and stop temperatures: (S) for summer or (W) for winter. Refer to sec. 5.2.2 to select the proper season.

- Select "10.Temp. Settings" from the main menu using the navigation buttons then press the right-arrow key.
- Use the down-arrow key to select the on or off temperature of a fan stage that needs to be adjusted.
- Use the adjustment buttons to adjust the start or stop temperature.
- Proceed in similar fashion for both winter and summer seasons. Refer to sec. 5.2.2 to select a season.

Stg 1 On	80.5	(S)
Stg 1 Off	80.0	(S)
Stg 2 On	82.0	(S)
Stg 2 Off	80.0	(S)

5.7.2 Adjusting Fans Stages' Timer

A fan stage can include certain relays configured to operate in timer mode. This feature may be used to operate cooling devices such as **Kool-Cel Pumps**. The ON and OFF times can be adjusted from 0 to 900 seconds, in increment of 15 seconds.

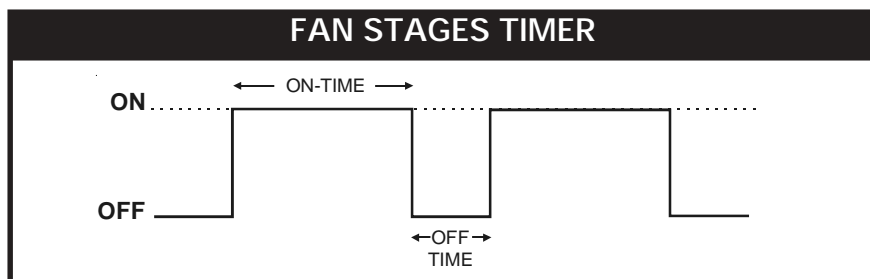

PP-32

- Set the function to "17. Fan Settings" from the main menu. Note that this menu is available only in the installer mode (see sec. 5.14.2).
- Press the right-arrow key once again to select the "1. Relays" menu.
- Select the stage that needs to be adjusted by using the navigation buttons then press the right-arrow key (the letter standing beside fan stages 1-4 represents the selected program, when applicable).

Ventilation Stage	▲
Relay Assignment	▼
3. Stage 1a	
4. Stage 2a	
- Press the down-arrow key and scroll all relays until the On-Time display is reached.

Relay 31	Off (1)
Relay 32	Off (1)
On Time	15 sec
Off Time	120 sec
- Use the adjustment buttons to adjust the On-Time to the desired value.
- Press the down-arrow key once again and use the adjustment buttons to set the Off-Time to the desired value.
- Press the left-arrow key to exit this menu.

5.8 HEATER SETTINGS

The PP-32 operates up to eight independent heater stages. A start and stop temperature is defined for each heating stage. The stop temperature must be at least 0.5° F (0.3° C) greater than the start temperature for a given heater and the start temperature cannot be greater than the set point. The number of heater stages needed and the sensor assignment for each stage is determined during the installation (see sec. 5.14.3 and 5.14.4). The following diagram shows the operation of a heater stage.

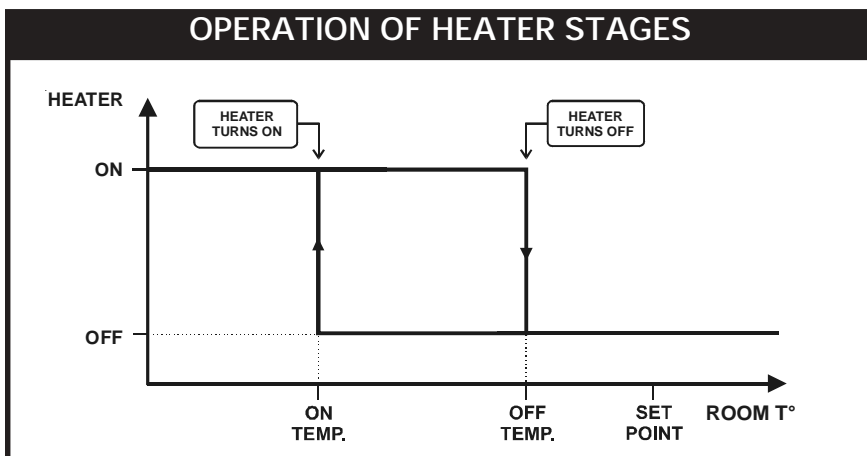

Start and stop temperatures of all heater stages can be set separately for summer and winter seasons. Refer to sec. 5.2.2 to select the proper season.

- Set the function to "10. Temp. Settings" from the main menu using the navigation buttons. The current set point is displayed.
- Press the down-arrow key to select the start or stop temperature of the desired heater stage.

Set Point:	70.°F	
Start/Stop Temp		▲▼
Heat 4 On	78.0(S)	
Heat 4 Off	79.0(S)	
- Use the adjustment buttons to set the Start or Stop temperature to the desired value.
- Proceed in similar fashion for both winter and summer seasons. Refer to sec. 5.2.2 to select the proper season.

5.9 AUXILIARY OUTPUTS

The PP-32 can control up to two auxiliary outputs. They are used as supplementary outputs for heating or cooling and may be used to control several devices such as chimney dampers, stir fans, lamps, heat mats, etc.

The user must specify if the auxiliary output operates in heating or in cooling mode. In heating mode, the output is activated whenever the temperature decreases below its start temperature. In cooling mode, the output is activated whenever the temperature increases above the start temperature.

1. In heating mode, the auxiliary output operates below its start temperature:

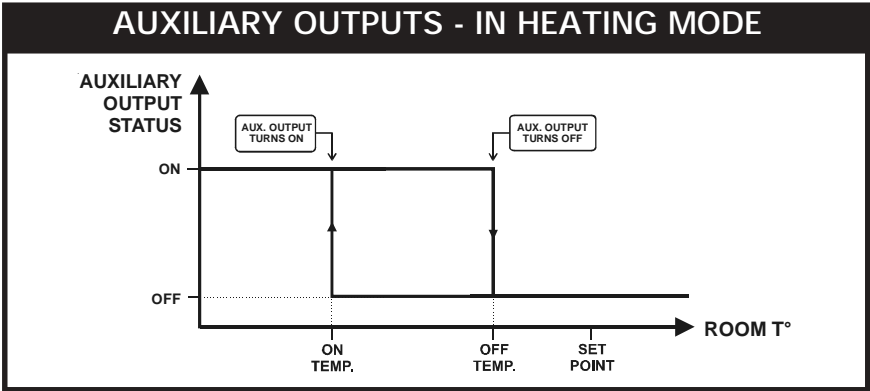

2. In cooling mode, the auxiliary output operates above its start temperature:

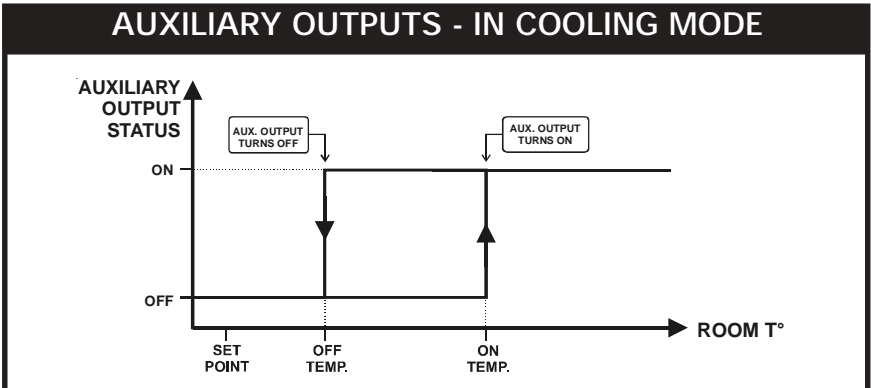



Refer to the installation setup to activate the auxiliary outputs and to select either if they operate in heating or cooling mode (sec. 5.14.3).

Adjusting Start/Stop Temperatures of Auxiliary Outputs

- In **heating mode**, the stop temperature (*Off Temp*) must be at least 0.5° F (0.3° C) greater than the start temperature (*On Temp*).

- In **cooling mode**, the start temperature (*OnTemp*) must be at least 0.5° F (0.3° C) greater than the stop temperature (*OffTemp*).

■ Set the function to "**10. Temp. Settings**" from the main menu using the navigation buttons the. The current set point is displayed.

■ Press the down-arrow key to select the start temperature of the first auxiliary output (*On T°*). Note that this menu only appears if auxiliary outputs have been enabled during the installation setup (see sec. 5.14.3).

Set Point: 80.0°F	▲ ▼
Start / Stop Temp	
Aux. 1 On 80.0°F	
Aux. 1 Off 80.5°F	

■ Use the adjustment buttons to set start temperature to the desired value.

■ Press the down-arrow key once. The stop temperature is selected (*Off Temp*).

■ Use the adjustment buttons to set stop temperature to the desired value.

■ Proceed in similar fashion for the other auxiliary output (if applicable).

5.10 ANIMAL AGE

The animal age is used as the reference day to determine the position in curves that are used by the controller (temperature curve, minimum ventilation curve). The controller also refers to the animal age to activate the proper clock output programs. The age can be adjusted from 0 to 450 days.



Note that all histories are cleared once the animal age goes from "OFF" to "1 day", except for the Alarm Log history.

In addition it is now possible to clear all histories without changing the animal age. Refer to section 5.12.1 for further information about the "Clear All" function.

Setting the Animal Age

- Set the function to "12. Animal Age" from the main menu using the navigation buttons. The current animal age is displayed.

Animal Age	15days
Clear All?	No

- Use the adjustment buttons to set the age to the desired value.

5.11 CLOCK OUTPUTS

The PP-32 has 4 clock outputs to control various devices, using the real-time clock. Refer to the installation setup section to activate the clock outputs (see sec. 5.14.3).

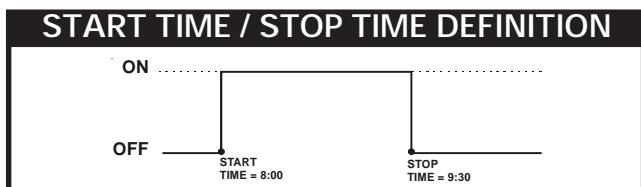

OPERATION OF CLOCK OUTPUTS 1 AND 2 :

The first 2 clock outputs can use up to 8 programs and each program has up to 10 start and stop times. The user determines at what day each program starts being used, this day is directly related to the animal age. This is true for all programs except for program 1. The first program is automatically enabled at day 1 (or at day 0 (Off)) and is deactivated when the start age of the following program is reached. When a new program starts, the previous program is deactivated. Refer to section 5.13.3 to enable the proper number of clock programs for clock outputs 1 and 2.

An alarm is set off when a clock program that has not been properly set is activated (this applies to clock programs 2-8). This means that an alarm occurs whenever a clock program that has all the same start and stop times (other than 12:00AM) is activated. In this case, the previous clock program keeps on running until the defective program is corrected.

CLOCK OUTPUTS 1-2							
PROGRAM 1	PROGRAM 2	PROGRAM 3	PROGRAM 4	PROGRAM 5	PROGRAM 6	PROGRAM 7	PROGRAM 8
ON / OFF 1	ON / OFF 1	ON / OFF 1	ON / OFF 1	ON / OFF 1	ON / OFF 1	ON / OFF 1	ON / OFF 1
ON / OFF 2	ON / OFF 2	ON / OFF 2	ON / OFF 2	ON / OFF 2	ON / OFF 2	ON / OFF 2	ON / OFF 2
ON / OFF 3	ON / OFF 3	ON / OFF 3	ON / OFF 3	ON / OFF 3	ON / OFF 3	ON / OFF 3	ON / OFF 3
ON / OFF 4	ON / OFF 4	ON / OFF 4	ON / OFF 4	ON / OFF 4	ON / OFF 4	ON / OFF 4	ON / OFF 4
ON / OFF 5	ON / OFF 5	ON / OFF 5	ON / OFF 5	ON / OFF 5	ON / OFF 5	ON / OFF 5	ON / OFF 5
ON / OFF 6	ON / OFF 6	ON / OFF 6	ON / OFF 6	ON / OFF 6	ON / OFF 6	ON / OFF 6	ON / OFF 6
ON / OFF 7	ON / OFF 7	ON / OFF 7	ON / OFF 7	ON / OFF 7	ON / OFF 7	ON / OFF 7	ON / OFF 7
ON / OFF 8	ON / OFF 8	ON / OFF 8	ON / OFF 8	ON / OFF 8	ON / OFF 8	ON / OFF 8	ON / OFF 8
ON / OFF 9	ON / OFF 9	ON / OFF 9	ON / OFF 9	ON / OFF 9	ON / OFF 9	ON / OFF 9	ON / OFF 9
ON / OFF 10	ON / OFF 10	ON / OFF 10	ON / OFF 10	ON / OFF 10	ON / OFF 10	ON / OFF 10	ON / OFF 10

CLOCK OUTPUTS 3-4
ON / OFF 1
ON / OFF 2
ON / OFF 3
ON / OFF 4
ON / OFF 5
ON / OFF 6
ON / OFF 7
ON / OFF 8
ON / OFF 9
ON / OFF 10

OPERATION OF CLOCK OUTPUTS 3-4 :

Clock outputs 3-4 operate using 10 start and stop times.

5.11.1 Adjusting Clock Output Start and Stop Times

- Set the function to "11.Clock Times" from the main menu using the navigation buttons then press the right-arrow key. This menu is only available if the clock outputs have been enabled in the installation setup (see sec. 5.14.3).
- Press the right-arrow key once again to select the "1.Start/Stop" menu.

- Use the navigation buttons to select the desired clock output. Press the right-arrow key.

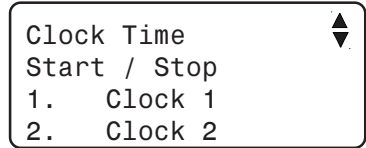

- If you have chosen Clock 1 or Clock 2, select the desired program use the arrow keys to select the proper program then press the right-arrow key.

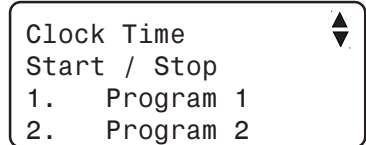

- Use the arrow keys to select the first start time (*On Time 1*) of the selected clock output.

- Use the adjustment buttons to adjust the first start time (*On Time 1*).

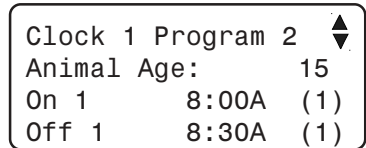

- Press the down-arrow key. The first off time of the selected clock flashes on the display (*Off Time 1*).

- Use the adjustment buttons to set the first off time to the desired value.

- Proceed in similar fashion to adjust all 10 start and stop times of all clock outputs.



If all 10 start and stop times are not needed, set the start and stop times of unused cycles to the same value (any value except for 12:00AM). When all start and stop times are set to 12:00AM, the output runs continuously, 24h.

5.11.2 Adjusting Starting Day of Clock Programs

Clock outputs 1 and 2 use up to 8 programs. The user determines at what day each program starts being used, this day is directly related to the animal age. This is true for all programs except for program 1. The first program is automatically enabled at day 1 (or at day 0 (Off)) and is deactivated when the start age of the following program is reached. When a new program starts, the previous program is deactivated.

- Set the function to "11.Clock Times" from the main menu using the navigation buttons then press the right-arrow key. This menu is only available if clock outputs have been enabled in the installation setup (see sec. 5.14.3).
- Press the right-arrow key once again to select the "1.Start/Stop" menu.
- Use the navigation buttons to select clock output 1 or 2 then press the right-arrow key.

Clock Time ▲▼
 Start / Stop
 1. Clock 1
 2. Clock 2
- Use the navigation buttons to select the desired program then press the right-arrow key. The animal age at which the selected program starts flashes on the display.

Clock Time ▲▼
 Start / Stop
 1. Program 1
 2. Program 2
- Use the adjustment buttons to set the age at which the selected program will start.
- Proceed in similar fashion to adjust the start age for each program of clock outputs 1 and 2 (if applicable).

Clock 1 Program 2 ▲▼
 Animal Age: 15
 On 1 8:00A (1)
 Off 1 8:30A (1)

5.12 HISTORY

5.12.1 Resetting Histories

The controller automatically resets all sensor histories when the animal age goes from "Off" to "1day". Note that this reset doesn't clear the Alarm Log history.

The following procedure shows how to clear all histories without having to change the animal age.

- Set the function to "12. Animal Age" from the main menu using the navigation buttons.
- Press the down-arrow key once to select the "Clear All?" menu.



If the following step is performed from the INSTALLER mode, **the Alarm Log will be lost**. If it is performed from the USER mode, the Alarm history will not be reset. Refer to section 5.14.3 to select the proper mode.

- Press \oplus to select Yes. The answer is validated after a 10 second delay. The display then returns to "No". Histories are now cleared.

Animal Age	Off
Clear All?	No

5.12.2 Average Temperature History

The controller has an history in which the minimum and maximum average temperature readings for the past 60 days are logged in.

- Set the function to "2. Average Temp." from the main menu using the navigation buttons then press the right-arrow key. The current average room temperature is displayed.
- Press the down-arrow key to scroll the menus. The minimum ($T^{\circ}L$) and maximum ($T^{\circ}H$) temperatures for the past 60 days are displayed.

5 days ago			
$T^{\circ}L$	72.3	$T^{\circ}H$	74.0
6 days ago			
$T^{\circ}L$	72.0	$T^{\circ}H$	74.3

5.12.3 Individual Temperature Sensors History

The controller has an history in which the minimum and maximum temperature readings of each sensor, for the past 10 days, are logged in.

- Set the function to "3.Temp. Sensors" from the main menu using the navigation buttons then press the right-arrow key. Sensors' temperature readings are displayed.

2 days ago			
T°1L	69.2	T°1H	75.4
T°2L	70.3	T°2H	74.0
T°3L	69.3	T°3H	74.2

- Press the down-arrow key to scroll the display. Sensors' Hi and Lo temperature readings are displayed for the past 10 days.

5.12.4 Outside Temperature Sensor History

The controller has an history in which the minimum and maximum temperature readings of the outside temperature sensor, for the past 10 days, are logged in.

- Set the function to "3.Temp. Sensors" from the main menu using the navigation buttons then press the right-arrow key. Sensors' temperature readings are displayed.
- Press the down-arrow key to scroll the display. The outside temperature sensors' Hi and Lo temperature readings (*OutL and OutH*) are displayed for the past 10 days.

2 days ago			
T°1L	69.2	T°1H	75.4
T°2L	70.3	T°2H	74.0
OutL	79.3	OutH	84.7

5.12.5 Relative Humidity History

The controller has an history in which the minimum and maximum humidity readings for the past 10 days are logged in.

- Set the function to "4.R. Humidity" from the main menu using the navigation buttons then press the right-arrow key. The current humidity level is displayed. This menu is only accessible if a humidity sensor has been installed (see sec. 5.14.3).

Min/Max Recorded			
RH L	81	RH H	84
Yesterday			
RH L	79	RH H	90

- Use the down-arrow key to scroll the display. Relative humidity's Hi and Lo readings are displayed for the past 10 days.

5.12.6 Water Consumption History

The controller has an history in which the water consumption, for the past 60 days, is logged in. The controller also displays the total water consumption since the last reset.

- Set the function to "**13. Water Consumption**" from the main menu using the navigation buttons then press the right-arrow key. The water consumption of the current day is displayed.

- Press the down-arrow key once. The total water consumption since the last reset is displayed.

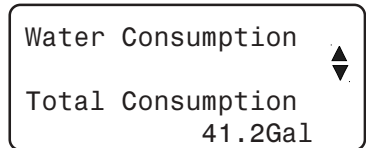

- Press the down-arrow key once again. The water consumption history is displayed. Keep pressing the down-arrow key to scroll the display and look at all histories.

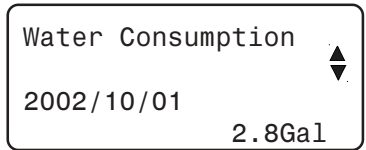

5.12.7 Heater Run Time History

The controller has an history in which the heater run times , for the past 60 days, are logged in. The controller also displays the total run time of heaters since the last reset.

- Set the function to "**14. Heater Run Time**" from the main menu using the navigation buttons then press the right-arrow key.

- Select the desired heater using the navigation buttons then press the right-arrow key. The heater run time for the current day is displayed.

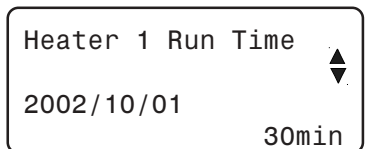

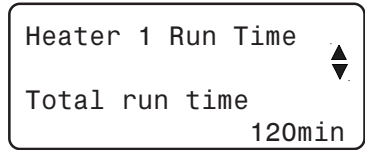

- Press the down-arrow key once, the total heater run time, since the last reset, is displayed.
- Keep pressing the down-arrow key to scroll the display. The Heater Run Time values recorded for the past 60 days are displayed. Keep pressing the down-arrow key to scroll the display and look at all histories.



5.13 ALARM SETTINGS

5.13.1 Alarm Log

When an alarm occurs, the light next to the alarm button  turns on and the alarm is logged along with the time and date. To view alarms in the alarm log, press the alarm button  then use the up and down-arrow keys to step through the recorded alarms. Refer to section 5.12.1 to clear the alarm log. A total of 10 alarms can be logged. The alarm conditions are as follows:

Display	Meaning
Low Temp Alarm	Low temperature alarm
High Temp Alarm	High temperature alarm
Low Pressure Alarm	Low Static Pressure Alarm
High Pressure Alarm	High Static Pressure Alarm
Inlet communication	Communication error with the DWR-F-1A module
Relay communication	Communication error with a relay
Program "x" fault, stage "y"	No relay is assigned for stage "y" of program "x".
Clock 1 or 2 fault, Program #"x"	Program "x" of clock output 1 or 2 is not set properly.
Sensor Defect 1-8	Sensor x is defective
Sensor Defect T° Out	Outside temperature sensor is defective

Another alarm situation occurs when power to the PP-32 fails. In this case, the alarm relay is activated. When the alarm relay is activated, the normally open contact  closes.

5.13.2 Setting Alarm Limits

The following diagram explains how temperature alarms are detected:

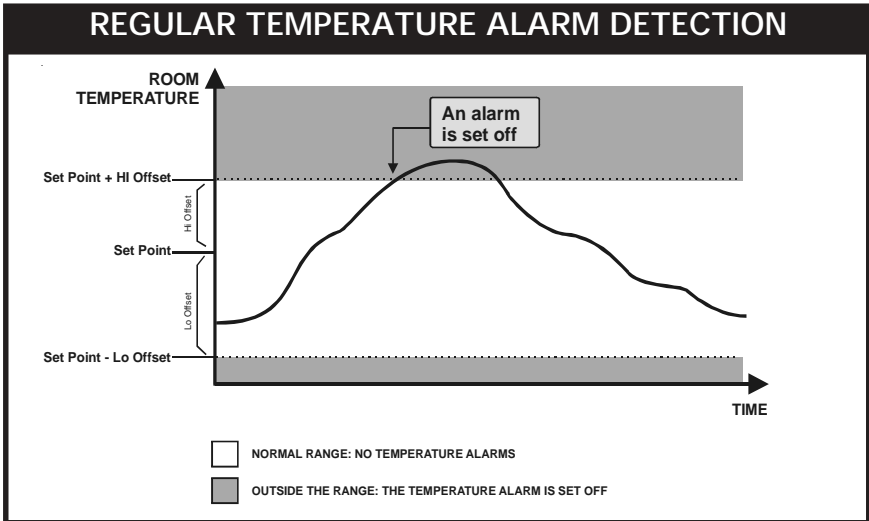

When the average room temperature exceeds the high temperature alarm setting (Set Point + Hi Offset), a high temperature alarm is generated. When the average room temperature drops below the low temperature alarm setting (Set Point - Lo Offset), a low temperature alarm is generated.

The critical temperature is the absolute maximum temperature allowed in the room.

Outside Temperature Influence on Alarms:

This feature avoids false alarms due to warm weather: the room temperature can exceed the Hi temperature limit in the case where the outside temperature is warm enough. The room temperature must remain equal or lower than *Outside T° + Outside Influence* or lower than *the Set Point + Hi Offset*, whichever is higher but in every case, it must remain below the critical temperature, no matter what the outside temperature is. The following diagram illustrates this situation:

ALARM DETECTION WITH OUTSIDE T° INFLUENCE

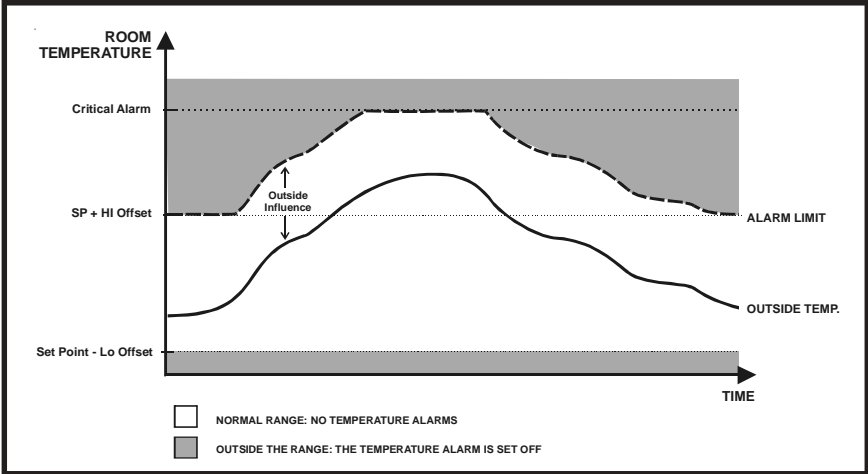

5.13.2.1 Adjusting Hi/ Lo Temperature Alarms

The low alarm temperature can be adjusted from 20° F to 0.5° F (11.1 to 0.3° C) below the set point (*Lo Offset*). The high alarm temperature can be adjusted from 0.5° F to 20° F (0.3 to 11.1° C) above the set point (*Hi Offset*). The offset is the number of degrees above or below the set point at which an alarm is set off.

- Set the function to "21.Alarm Limits" from the main menu using the navigation buttons then press the right-arrow key.
- Press the right-arrow key once again, in to select the "1.Temperature" menu. Lo and Hi Offsets are displayed.
- Use the adjustment buttons to set the Lo and Hi offsets to the desired

Temperature Alarm	
Lo Offset T°	10.0
Hi Offset T°	15.0
Critical	95.0°F

values.

5.13.2.2 Adjusting Critical Temperature

The critical temperature is the absolute maximum temperature allowed in the room.

- Set the function to "**21.Alarm Limits**" from the main menu using the navigation buttons then press the right-arrow key.
- Press the right-arrow key once again, in to select the "**1.Temperature**" menu.
- Press the down-arrow key in order to select the critical temperature menu.
- Use the adjustment buttons to adjust the critical temperature to the desired value.

Temperature Alarm	
Lo Offset T°	10.0
Hi Offset T°	15.0
Critical	95.0°F

5.13.2.3 Adjusting the Outside Temperature Influence

The outside temperature influence is the number of degrees that are added to the outside temperature to avoid false alarms on warm days. Refer to the previous diagram.

- Set the function to "**21.Alarm Limits**" from the main menu using the navigation buttons then press the right-arrow key.
- Press the right-arrow key once again, in to select the "**1.Temperature**" menu.
- Press the down-arrow key in order to select the "**Out. Influence**" display. Note that this menu only appears if the outside temperature sensor has been enabled during the installation (see sec. 5.14.3).
- Use the adjustment buttons to adjust the Outside Temperature Influence to the desired value.

Temperature Alarm	
Lo Offset T°	10.0
Hi Offset T°	15.0
Out. Influence	5.0

5.13.2.4 Adjusting Static Pressure Alarms

The controller can generate an alarm if the static pressure drops below the low pressure limit or if it exceeds the high pressure limit. The controller uses a delay before activating the alarm. If the static pressure exceeds the high or low limits for that delay, an alarm is generated.

LO STATIC PRESSURE ALARM:

The user can assign a relay that will be activated when a Low Static Pressure Alarm occurs. This relay may activate a fan output for instance. When this type of alarm occurs, the relay turns on for a 15 minute delay. If the static pressure level is still below the Low Pressure Limit after the delay has elapsed, the relay remains activated for another 15 minutes, up until the pressure level goes back into the normal range once again.

Set the Lo Alarm Limit to *Off* to deactivate this feature.

HI STATIC PRESSURE ALARM:

When a high static pressure alarm occurs, the controller can open both vent doors and the tunnel curtain. The curtain or vent doors open during a user-defined delay (*Open-Time*) and then stay still for a total time of 15 minutes (this time includes the *Open-Time*). If the pressure level still exceeds the Hi Static Pressure Limit after this delay, the same cycle starts over again, up until the pressure level goes back into the normal range.

Adjusting Hi/Lo Static Pressure Alarm Limits

- Set the function to "**21.Alarm Limits**" from the main menu using the navigation buttons then press the right-arrow key.
- Use the navigation buttons to select "**2.Static Pressure**" then press the right-arrow key.
- Press the right-arrow key once again in order to select the "**1.Hi/Lo limits**" option. The Lo and Hi pressure limits are displayed.
- Use the adjustment buttons to set

Static Press Alarm	
Low Alarm	.015"WC
Hi Alarm	.150"WC

the Low alarm limit to the desired value.

- Press the down-arrow key to select the Hi alarm limit.
- Use the adjustment buttons to set the Hi alarm limit to the desired value.

Note : If you do not want a relay to be turned off in the case of a low static pressure alarm, set the Low Alarm limit to "Off" by pressing the down-arrow key.

Adjusting High/Low Delays

- Set the function to "21.Alarm Limits" from the main menu using the navigation buttons then press the right-arrow key.
- Use the navigation buttons to select "2.Static Pressure" then press the right-arrow key.
- Press the right-arrow key once again in order to select the "1.Hi/Lo limits" option. The Lo and Hi pressure limits are displayed.
- Press the down-arrow key in order to select the "Lo Delay" display.
- Use the adjustment buttons to set the Lo Pressure Alarm Delay to the desired value.
- Press the down-arrow key once again to select the "Hi Delay" display.

Low Alarm	.030"WC
Hi Alarm	.150"WC
Lo Delay	60sec
Hi Delay	300sec

- Use the adjustment buttons to set the Hi Pressure Alarm Delay to the desired value.

Adjusting the Open-Time for the Hi Static Pressure Alarm

The Open-Time of the tunnel curtain or vent doors, in case a Hi static pressure alarm occurs, can be adjusted from 0 to 900 sec.

- Set the function to "**21.Alarm Limits**" from the main menu using the navigation buttons.

- Use the navigation buttons to select "**2.Static Pressure**" then press the right-arrow key.

Hi Static Alarm	
Open Vents sec	30
Open Tunnel sec	30

- Press the right-arrow key once again in order to select the "**3.Hi Static Alarm**" option. The opening time of vent doors and of the tunnel curtain are displayed.

- Use the adjustment buttons to adjust vents doors' Open-Time.
- Press the down-arrow key once to select curtain's Open-Time.
- Use the adjustment buttons to adjust curtain's Open-Time.

5.13.3 Resetting the Alarm Log

Resetting the alarm log can only be performed from the installer mode.

- Set the function to "**19.Installation**" from the main menu using the navigation buttons then press the right-arrow key. The "**Clear Alarms**" menu is selected. Note that this menu is only accessible from the installer mode (see sec. 5.14.2).
- Use the adjustment buttons to select "Yes", in order to clear the alarm log. The answer is validated after an 8 second delay or when the user exits the menu.

5.14 INSTALLATION

5.14.1 Step-by-Step Installation Guide

These are the basic steps to start-up your PP-32 controller.

1. Connect the control according to the wiring diagram enclosed with this manual.
2. Turn on the power.
3. Adjust the **Date and Time** (sec. 5.14.5).
4. Select the proper season and program, if applicable (sec. 5.2.1, 5.2.2).
5. Step through the "**19. Installation**" menu and answer all questions in order to customize the controller for your particular application (see sec. 5.14.3).
6. Adjust dip switches. Refer to the dip switch table in section 4.2.
7. Assign output relays. The relay assignment may only be performed from the installer mode (see sec. 5.14.2). Refer to section 5.14.6 to assign the following relays:
 - Assign relays for each heater stage.
 - Assign relays for each fan stage;
 - Assign relays for the vent doors, if applicable;
 - Assign relays for the tunnel curtain, if applicable.
 - Assign relays for each clock output, if applicable.
 - Assign relays for each auxiliary output, if applicable.
 - Assign relays for the Low Static Pressure Alarm, if applicable.
8. Sensor assignment (see sec. 5.14.4):
 - Sensors must be assigned for each heating stage. Heater stages use the average temperature of their assigned sensors to operate.
 - Sensors must be assigned to be part of the average room temperature. Fan stages operate according to this average temperature.
 - Sensors must be assigned to each air inlet, in the case where DWR-F-1A modules are used. Inlets use the average temperature of their assigned sensors to operate.

9. Adjust the temperature set point. This is the target temperature in the room. Refer to section 5.3.
10. Adjust the start/stop temperature of fan stages (see sec. 5.7) and heater stages (see sec. 5.8).
11. Adjust the minimum ventilation cycle settings (see sec. 1.1.1).
12. If inlets operate using DWR-F-1A modules, set the air inlet compensation. This feature helps to reduce temperature differences in the building (see sec. 5.5.1).
13. Adjust all vent door parameters, if applicable (see sec 5.5.2).
14. Adjust all tunnel curtain settings, if applicable (see sec 5.6).
15. Calibrate the water counter, if applicable (see sec. 5.14.7).
16. Enable the desired options to control the humidity level in the barn (see sec. 5.15.3).
17. Adjust and activate the temperature curve (optional). This feature allows the temperature set point to be automatically adjusted over time (see sec. 5.15.1).
18. Adjust and activate the minimum ventilation curve (optional). This feature allows fans' On-Time, in minimum ventilation, to be automatically adjusted over time (see sec. 5.15.2).
19. Adjust start/stop times of each clock output. These outputs allow to operate various devices according to timer cycles (see sec. 5.11).
20. Adjust start/stop temperatures of each auxiliary output. These outputs allow to operate various devices according to the room temperature (see sec. 5.9).
21. Adjust the animal age (see sec. 5.10). To clear previous histories, the animal age must first be set to "Off" and then be changed for "1 day".

5.14.2 Password Settings

This function allows to identify 2 different user types. It is used to restrict the access to certain parameters. The password is made up of three blocks of two digits, for example: 13 44 21. When a correct password is entered, the current user is identified.

Installer Password: By default, the INSTALLER PASSWORD is set to "01-01-01". The installer mode gives full access to all functions of the PP-32. The controller automatically returns to the user mode after 15 minutes of inactivity. The installer may return to the user mode before that delay by entering the user password. The installer's password can be modified.

User Password: The user mode gives access to the basic functions of the PP-32. By default this password is set to "01-02-03". Some menus will not be accessible from this mode. This password cannot be modified. The control automatically goes back to the user mode after 15 minutes of inactivity.

Entering the Installer's Password:

- Set the function to "22.Password" from the main menu using the navigation buttons then press the right-arrow key. The current user mode is displayed.

Password ◀▶

Current mode:
User 1

- Press the right-arrow key once again to enter a password. The first two-digit number are flashing. Use the adjustment buttons to set the first number. Press the right-arrow key once, the second two-digit number is selected. Use the adjustment buttons to set the second number. Proceed in similar fashion to set the third two-digit number. Press the right-arrow another time to validate the whole password.

Password ◀▶

Enter password:
01 ** **

- If the entered password is incorrect, the error message "Wrong Password" is displayed.

Password ◀▶

Wrong password!

Modifying the Installer's Password

The installer's password must first be entered before being allowed to modify it. Proceed as explained above to enter the installer password (1-1-1 by default).

Note : The password "1-2-3" is reserved for the user mode. Do not use the same number sequence for the installer password.

- Set the function to "19.Installation" from the main menu using the navigation buttons. Press the right-arrow key. Note that this menu is only accessible from the installer mode (refer to the previous section to enter the installer's password).

Installation	▲
Clear Alarms?	No
Reset Min/Max	11:00A
Use RH?	Yes

- Press the down-arrow key and scroll the display until you reach the Installer's Password menu.
- Use the adjustment buttons to adjust all three numbers of the installer's password.
- Once the new Installer Password is correctly set, press the left-arrow key to exit this menu.

Installer Password	
code #1	1
code #2	1
code #3	1

5.14.3 Installation Setup

The following section describes how to customize the controller for your particular application. Normally, this setup needs to be done only once.

Parameters are presented below in the order they appear on the display. Use the adjustment buttons to adjust a parameter value. When you are finished adjusting a parameter, press the down-arrow key to move to the next parameter. The user should step through all the parameters at least once. These parameters are located in the "19.Installation" main menu. Note that this menu is only accessible on the installer mode (see sec. 5.14.2).

1. Clear Alarms:

Set to "Yes" to reset the alarm log.

2. Reset Time:

Set the time at which minimum and maximum readings of all sensors are logged into the history.

3. Use RH?:

Set to "Yes" if a humidity sensor is connected to the controller.

Installation	▲▼
Clear Alarms?	No
Reset Min/Max	11:00A
Use RH?	Yes
PreOpenVents sec	10
PreOpen Tun sec	30
Use Tunnel ?	Yes
Tunnel Mode:	SP

4. Pre-Open Vent Door Delay:

Set the pre-opening delay of vent doors to the desired value. This delay can be adjusted from 0 to 60 seconds. Note that this menu only appears if the static pressure sensor is enabled on #8 below

5. Pre-Open Tunnel Delay:

Set the pre-opening delay of the tunnel curtain to the desired value. This delay can be adjusted from 0 to 30 seconds. Note that this menu only appears if the tunnel is enabled on #6 below.

6. Use Tunnel ?:

Set to "Yes" to enable the tunnel ventilation mode.

7. Tunnel Mode:

Select either the tunnel curtain is controlled in timer mode (*Timer*) or by the static pressure level (*SP*). This menu only appears if the tunnel is enabled on #6 above.

8. Use Static Pressure ?

Set to "Yes" to activate the static pressure sensor.

9. Static Pressure Set 2.

Select whether the activation of the second group of static pressure set points is related to a specific stage (*Stage*) or to the outside temperature (*Out T°*). Refer to section 5.5.2 for further information on this feature.

Use Stat. pres?	Yes
Static Set. 2	Stage
# Inlets	12
# Auxiliary Out.	2
Aux. 1 Mode:	Heat
Aux. 2 Mode:	Cool
# Fan Stages	16
# Stg Programs	abc
# Heater Stages	8

10. # of Inlets:

Select the proper number of air inlets. Each air inlet is related to a DWR-F-1A module. Note that this menu only appears if the static pressure sensor is deactivated on #8 above. Up to 12 air inlet can be activated.

11. # of Auxiliary Outputs

Select the proper number of auxiliary outputs.

12. Auxiliary Output Mode

Select whether auxiliary outputs 1 and 2 operate in Heating or in Cooling mode. Up to 2 auxiliary outputs can be activated.

13. # of Fan Stages

Set the number of fan stages to the desired value. Up to 16 fan stages can be activated.

14. # of Stage Programs

Select the number of stage programs that will be used by the controller. Up to 4 programs can be selected:

None = 1 program only, **ab** = 2 programs,
abc = 3 programs, **abcd** = 4 programs

15. # of Heater Stages

Set the number of heater stages to the desired value. Up to 8 heater stages can be activated.

16. # of Clock Outputs:

Set the number of clock outputs to the desired value. Up to 8 clock outputs can be activated.

# Clocks	4
# Clock 1 Prog	8
# Clock 2 Prog	8
# Sensors	8
Use Out. Temp?	Yes
Contrast	70%
Installer Password	
code #1	1
code #2	1
code #3	1

17. # of Clock Programs for Clock Outputs 1 & 2 :

Set the number of programs for clock outputs 1 & 2. Up to 8 programs can be activated for the first 2 clock outputs.

18. # of Sensors :

Select the number of temperature sensors in the room. Up to 8 sensors can be used.

19. Use Outside Temperature Sensor ?

Set to "Yes" if an outside temperature sensor is connected to the controller.

20. Installer Password

Set the 3 two-digit numbers of the installer's password to the desired value.

5.14.4 Sensor Assignment

5.14.4.1 Assigning Sensors to the Room T° and Fan Stages

The controller uses the average reading of activated sensors to calculate the room temperature. Fan stages use this temperature to operate.

The selection of sensors that are used to determine the average room temperature differs depending on the selected program. Therefore, the user must make a separate sensor assignment for each program in use. Note also that sensor assignment can only be done from the installer mode (see sec. 5.14.2).

- Set the function to "**17.Fan Settings**" from the main menu using the navigation buttons. Note that this menu is only available in the installer mode (see sec. 5.14.2).

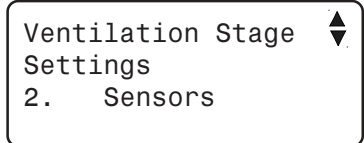

- Press the down-arrow key once to select "**2.Sensors**" menu then press the right-arrow key.

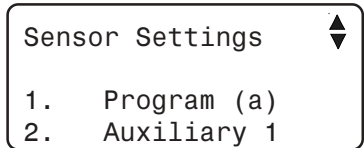

- Press the right-arrow key once to select "**1.Program (x)**" or "**1.Sensor Selection**" menu (depending if many programs are activated). Sensors that have been activated during the installation are displayed (see sec. 5.14.3).

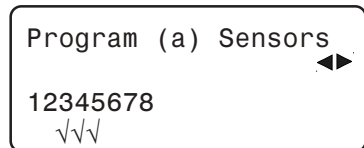

- Use the right and left-arrow keys to select the desired sensor. When the item is flashing, press (+) to activate the sensor or (-) to deactivate it. **The selected sensors are used to calculate the average room temperature into the selected program.**
- Proceed in similar fashion to activate the proper sensors for each program. Refer to sec. 5.2 to select another program.

5.14.4.2 Assigning Sensors to Heater Stages

Heater stages use the average temperature of their assigned sensors to operate. The assignment of heater stages is common to all programs and can only be set in the installer mode (see sec. 5.14.2). Select sensors that are used for the operation of each heater stage as follows:

- Set the function to "**16.Heater Settings**" from the main menu using the navigation buttons. Note that this menu is only available in the installer mode (see sec. 5.14.2).

- Press the down-arrow key once to select "**2.Heater Sensors**" menu then press the right-arrow key.

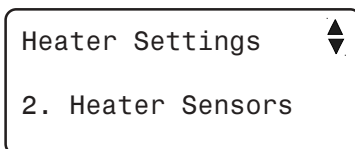

- Use the navigation buttons to select the desired heater stage then press the right-arrow key. Sensors that have been activated during the installation are displayed (see sec. 5.14.3).

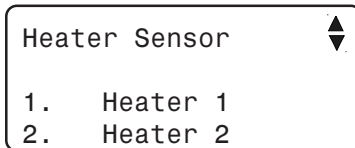

- Use the right and left-arrow keys to select the desired sensor. When the item is flashing, press (+) to activate the sensor or (-) to deactivate it.

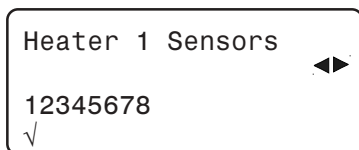

5.14.4.3 Assigning Sensors to Air Inlets

Air inlets use the average temperature of their assigned sensors to operate. Select the proper sensors of each air inlet as follows:

- Select "**8.Inlet Settings**" from the main menu using the navigation buttons then press the right-arrow key. Note that this menu is only available if the static pressure sensor is disabled and if inlets have been activated during the installation setup (see sec. 5.14.3).

- Select "**2.Inlet Sensors**" then press the right-arrow key. This option is only available in the installer mode (see sec. 5.14.2).

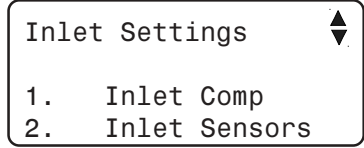

- Use the navigation buttons to select the desired inlet then press the right-arrow key. Sensors that have been activated during the installation are displayed (see sec. 5.14.3).

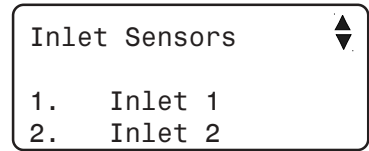

- Use the right and left-arrow keys to select the desired sensor. When the item is flashing, press (+) to activate the sensor or (-) to deactivate it.

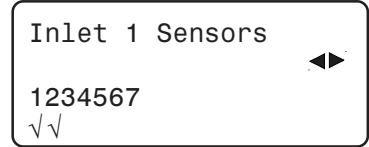

- Proceed in similar fashion to assign sensors to each air inlet in use.

5.14.4.4 Assigning Sensors to Auxiliary Outputs

Auxiliary outputs use the average temperature of their assigned sensors to operate. This parameter is common to all programs and can only be set in the installer mode (see sec. 5.14.2). Select sensors that are used for the operation of each auxiliary output as follows:

- Set the function to "**17.Fan Settings**" from the main menu using the navigation buttons. Note that this menu is only available in the installer mode (see sec. 5.14.2).

- Press the down-arrow key once to select "**2.Sensors**" menu then press the right-arrow key.

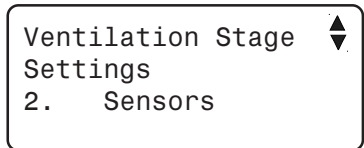

- Use the navigation buttons to select "**2.Auxiliary 1**" or "**3.Auxiliary 2**" menu. Sensors that have been activated during the installation are displayed (see sec. 5.14.3).

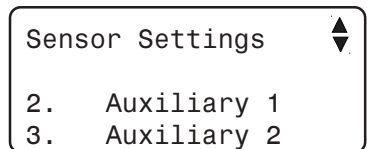

- Use the right and left-arrow keys to select the desired sensor. When the item is flashing, press (+) to activate the sensor or (-) to deactivate it.

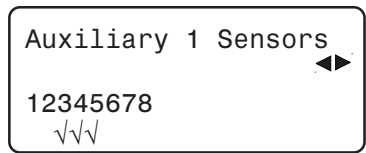

- Proceed in similar fashion to assign sensors to the second auxiliary output, if applicable.

5.14.5 Setting Time and Date

- Set the function to "20.Time / Date" from the main menu using the navigation buttons. Press the right-arrow key. The current time and date are displayed.
- Press the right-arrow key once. The year is selected. Use the adjustment buttons to set the year. Press the right-arrow key once again, the month is selected. Use the adjustment buttons to set the month. Press the right-arrow key. The day is selected. Use the adjustment buttons to set the day to the proper value.
- Press the right-arrow key once again, hours are selected. Use the adjustment buttons to set the hours. Press the right-arrow key. Minutes are selected. Use the adjustment buttons to set the minutes. Press the right-arrow key. Seconds are selected. Use the adjustment buttons to adjust the seconds.
- Press the left-arrow several times, in order to exit this menu.

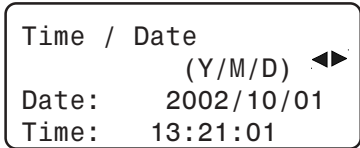

5.14.6 Relay Assignment

The PP-32 controller has 32 integrated ON/OFF relays. The mapping between the stages and relays is determined by the user. **Fill out the template at the end of this manual to map the relays before assigning them from the front panel.** Note that relay assignment can only be done in the installer mode (see sec 5.14.2).

Relays with a mark underneath are assigned to the selected output. Use the right and left-arrow keys to scroll the display and select the desired relay.

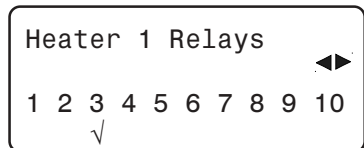

HINT: Pressing the UP or DOWN arrow keys acts as a page-up & page-down function. This makes it easier to step through the relays.

RELAY ASSIGNMENT EXAMPLE

(an empty template is available at the end of this manual)

OUTPUT/RELAY #	1	2	3	4	5	6	7	8	9	10	11	12	13	14	15	16	17	18	19	20	21	22	23	24	25	26	27	28	29	30	31	32						
Heater Stage 8																																						
Heater Stage 7																																						
Heater Stage 6																																						
Heater Stage 5	x	x	x	x	x																																	
Heater Stage 4	x	x	x	x																																		
Heater Stage 3	x	x	x																																			
Heater Stage 2	x	x																																				
Heater Stage 1	x																																					
Cooling Stage 1 (a)						x																																
Cooling Stage 1 (b)						x														x	x																	
Cooling Stage 1 (c)																																						
Cooling Stage 1 (d)																																						
Cooling Stage 2 (a)						x	x																															
Cooling Stage 2 (b)						x	x														x	x																
Cooling Stage 2 (c)																																						
Cooling Stage 2 (d)																																						
Cooling Stage 3 (a)						x	x	x																														
Cooling Stage 3 (b)						x	x	x													x	x																
Cooling Stage 3 (c)																																						
Cooling Stage 3 (d)																																						
Cooling Stage 4 (a)						x	x	x	x																													
Cooling Stage 4 (b)						x	x	x	x												x	x																
Cooling Stage 4 (c)																																						
Cooling Stage 4 (d)																																						
Cooling Stage 5						x	x	x	x	x								T		x	x																	
Cooling Stage 6						x	x	x	x	x	x							T		x	x																	
Cooling Stage 7						x	x	x	x	x	x	x						T		x	x																	
Cooling Stage 8																																						
Cooling Stage 9																																						
Cooling Stage 10																																						
Cooling Stage 11																																						
Cooling Stage 12																																						
Cooling Stage 13																																						
Cooling Stage 14																																						
Cooling Stage 15																																						
Cooling Stage 16																																						
Vent Doors Open																	x																					
Vent Doors Close																x																						
Curtain Opens																																					x	
Curtain Closes																																				x		
Clock Output 1																						x																
Clock Output 2																							x															
Clock Output 3																								x														
Clock Output 4																									x													
Auxiliary Output 1																										x												
Auxiliary Output 2																											x											
Lo Static P. Alarm																																				x		
Lo Static P. Fans						x	x														x	x																

5.14.6.1 Assigning Fan Stages' Relays

Ventilation stages 1 to 4 use a separate relay assignment for each program in use. Refer to sec. 5.2 to select the proper program.



MAKE SURE EVERY FAN STAGE HAS RELAYS ASSIGNED TO IT!
An alarm is set off whenever a fan stage, that doesn't activate any relay, is activated. In this case, all relays of the previous fan stage are copied into this stage.

- Set the function to "17.Fan Settings" from the main menu using the navigation buttons then press the right-arrow key. Note that this menu is only available in the installer mode (see sec. 5.14.2).
- Press the right-arrow key once again to select the "1.Relays" menu.

- Use the adjustment buttons to select the proper fan stage then press the right-arrow key. The letter that stands beside stages 1-4 corresponds to the current program in use (if applicable).

Ventilation Stage ▲▼
 Relay Assignment
 3. Stage 1a
 4. Stage 2a

- Use the up and down-arrow keys to select the desired relay. When the item is flashing, press (+) to activate the relay or (-) to deactivate it.

Stage 1a Relays:
 Relay 1 On(1) ◀▶
 Relay 2 Off(1)
 Relay 3 Off(1)

- Proceed in similar fashion to assign relays for each fan stage.

TIMER RELAYS ON FAN STAGES:

The user can configure certain relays to operate in timer mode for cooling while other relays operate in ON/OFF mode. For example, a Kool-Cel Pump can operate according to a timer mode, using a fan stage output. The Kool-Cel Pump will then operate while fan stages continue running at the same time. Timer relays can only be set on fan stage outputs. Refer to section 5.7.2 to set the timers' ON and OFF time settings.

To assign relays on timer mode, proceed as described above and use the adjustment buttons to select the "Timer" option.

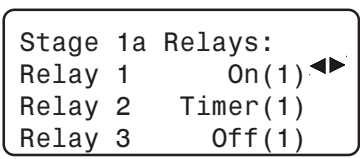

5.14.6.2 Assigning Heater Stages' Relays

- Set the function to "16.Heater Settings" from the main menu using the navigation buttons then press the right-arrow key. Note that this menu is only available in the installer mode (see sec. 5.14.2).
- Press the right-arrow key once again to select the "1.Relays" menu.
- Use the navigation buttons to select the desired heater stage then press the right-arrow key.

- Use the right and left-arrow keys to select the desired relay. When the item is flashing, press (+) to activate the relay or (-) to deactivate it.

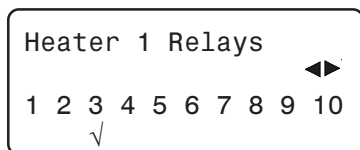

- Proceed in similar fashion to assign relay(s) for each heater stage.

5.14.6.3 Assigning Relays to Vent Doors

Relays 13-14, 15-16, 29-30 and 31-32 have specially been designed for vent doors, air inlets or tunnel curtain. It is strongly recommend to use these relays to open/close these devices: this prevents activating the OPEN and CLOSE relays, by inadvertence, at the same time.

ASSIGNING VENT DOORS OPEN / CLOSE RELAYS:

- Set the function to "8.Vent Doors" from the main menu using the navigation buttons then press the right-arrow key. Note that this menu is only available in the installer mode (see sec. 5.14.2) and if vent doors have been enabled during the installation setup (see sec 5.14.3).

- Use the navigation buttons to select the "2. Relay Settings" menu then press the right-arrow key.
- Use the navigation buttons to select the "1. Open Relay" or "2. Close Relay" menu then press the right-arrow key.
- Use the right and left-arrow keys to select the desired relay. When the item is flashing, press (+) to activate the relay or (-) to deactivate it.

```
Vent Door
Open Relay      ◀▶
13 14 15 16 17 18 19
√
```

5.14.6.4 Assigning Relays to the Tunnel Curtain

Relays 13-14, 15-16, 29-30 and 31-32 have specially been designed for vent doors, air inlets or tunnel curtain. It is strongly recommend to use these relays to open/close these devices: this prevents activating the OPEN and CLOSE relays, by inadvertence, at the same time.

ASSIGNING CURTAIN'S OPEN / CLOSE RELAYS:

- Set the function to "9. Tunnel Curtain" from the main menu using the navigation buttons then press the right-arrow key. Note that this menu is only available in the installer mode (see sec 5.14.2) and if the tunnel curtain has been enabled during the installation setup (see sec. 5.14.3).
- Use the navigation buttons to select the "2. Relay Settings" menu then press the right-arrow key.
- Use the navigation buttons to select the "1. Open Relay" or "2. Close Relay" menu then press the right-arrow key.
- Use the right and left-arrow keys to select the desired relay. When the item is flashing, press (+) to activate the relay or (-) to deactivate it.

```
Tunnel Curtain
Open Relay      ◀▶
13 14 15 16 17 18 19
√
```

5.14.6.5 Assigning Relays to Clock Outputs

- Set the function to "11.Clock Times" from the main menu using the navigation buttons then press the right-arrow key. Note that this menu is only available in the installer mode (see sec. 5.14.2) and if clock outputs have been enabled during the installation setup (see sec. 5.14.3).
- Use the navigation buttons to select the "2. Clock Relays" menu then press the right-arrow key.
- Use the navigation buttons to select the desired clock output then press the right-arrow key.
- Use the right and left-arrow keys to select the desired relay. When the item is flashing, press (+) to activate the relay or (-) to deactivate it.

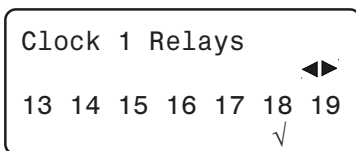

5.14.6.6 Assigning Relays to Auxiliary Outputs

- Set the function to "17.Fan Settings" from the main menu using the navigation buttons then press the right-arrow key. Note that this menu is only available in the installer mode (see sec. 5.14.2) and if auxiliary outputs have been enabled during the installation setup (see sec. 5.14.3).
- Press the right-arrow key to select the "1.Relays" menu.
- Use the navigation buttons to select the desired auxiliary output then press the right-arrow key.
- Use the right and left-arrow keys to select the desired relay. When the item is flashing, press (+) to activate the relay or (-) to deactivate it.

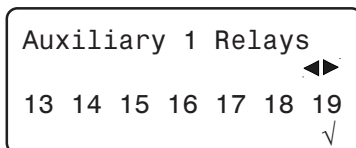

5.14.6.7 Assigning Relays for the Lo Static Pressure Alarm

This relay is activated if a low static pressure alarm occurs. Refer to sec. 5.13.2 to activate/deactivate the low static pressure alarm.

- Set the function to "**21.Alarm Limits**" from the main menu using the navigation buttons then press the right-arrow key.

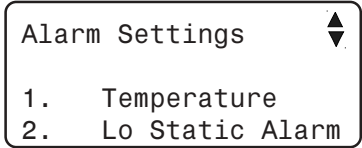

- Use the navigation buttons to select "**2.Static Pressure**" then press the right-arrow key. Note that this menu is only accessible if the static pressure sensor has been enabled in the installation setup (see sec. 5.14.3).

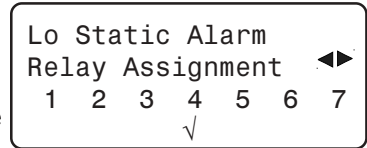

- Use the navigation buttons to select the "**2. Lo Static Alarm**" menu then press the right-arrow key.
- Use the right and left-arrow keys to select the desired relay. When the item is flashing, press (+) to activate the relay or (-) to deactivate it.

5.14.7 Calibrating the Water Counter

The PP-32 provides a pulse input to monitor the water consumption. The user must enter the water flow per pulse, it can be adjusted from 1 to 100 gallons per pulse.

- Set the function to "**13. Water Consumption**" from the main menu then press the right-arrow key. The water consumption of the current day is displayed.
- Press the up-arrow key once. The water flow per pulse is displayed.
- Use the adjustment buttons to set the water flow per pulse to the desired value.

Water Consumption				▲
Calib:				▼
Min	1	Max	100	

5.15 ADVANCED SETTINGS

5.15.1 Setting the Temperature Curve

The user can define a temperature curve to adjust the set point automatically over a given time period.

A curve is defined using up to 10 points. Each point specifies a day number and a set point for that day. The animal age defines the current day number that is used by the curve. Once the points of the curve are defined, the curve must be activated. The controller will change the temperature set point every hour in a linear fashion between consecutive points of the curve. When the last point of the curve is reached, the temperature set point for that day is maintained until the animal is set back to 0 (*Off*).

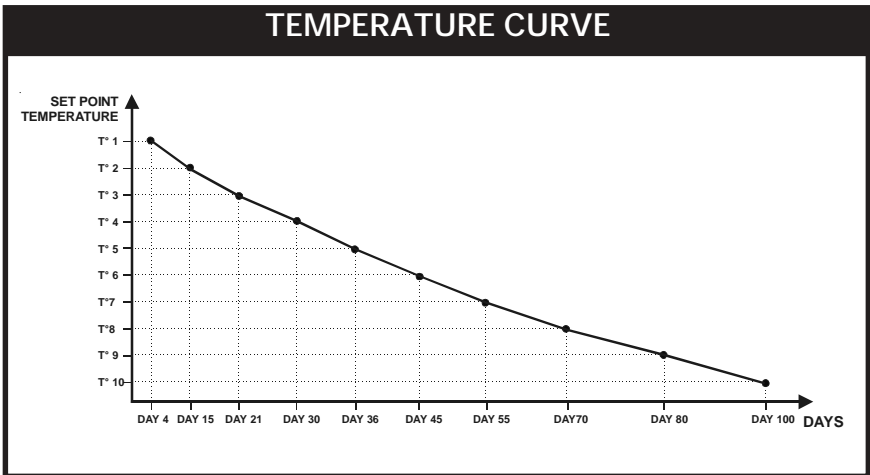

NOTES:

- i) All ten points of the curve must be specified. If ten points are not needed, repeat the last temperature value for each unnecessary point.
- ii) Certain restrictions apply to reduce the risk of errors:
 - The highest possible day number is 450.
 - Decreasing day numbers are not allowed.
 - Increasing temperatures are not allowed.



Note that the temperature curve must be turned off to adjust its points and days. Use the down-arrow key to scroll each point of the curve. The curve status then flashes on the display. Use the adjustment buttons to turn it Off.

- Set the function to "6.Room Set Point" from the main menu then press the right-arrow key. The current set point and the curve status are displayed.

Room Set Point	▼
Temperature	
Set Point: 70.0°F	
Curve stat Off	

- Press the down-arrow key once. The first day, corresponding to the first point of the curve flashes on the display.

Room Set Point	▲▼
Temperature	
Day: 1	
Temp: 78.0°F	

- Use the adjustment buttons and set the first day of the curve to the desired value.
- Press the down-arrow key once again. The temperature for the first point of the curve flashes on the display.
- Use the adjustment buttons to adjust the temperature for the first point of the curve to the desired value.
- Press the down-arrow key to display and adjust all other points of the curve.
- Once they are all properly set, press the down-arrow key. The curve state flashes on the display. Press (+) to activate the curve.

NOTE: All ten points of the curve must be specified. If ten points are not needed, repeat the last temperature value for each unnecessary point.

5.15.2 Setting the Minimum Ventilation Curve

Fans' On-Time, in minimum ventilation, can automatically be adjusted over a given period of time, by using the minimum ventilation curve.

The On-Time changes using 10 steps. Each step specifies a day number and an On-Time value for that day. The animal age defines the current day number used by the curve. Once the 10 steps are defined, the curve must then be activated. The controller changes the On-Time, in minimum ventilation, every hour in a linear fashion between consecutive steps of the ramping curve. When the last step is reached, the fans' On-Time for that day is maintained until the animal age is set back to Off.

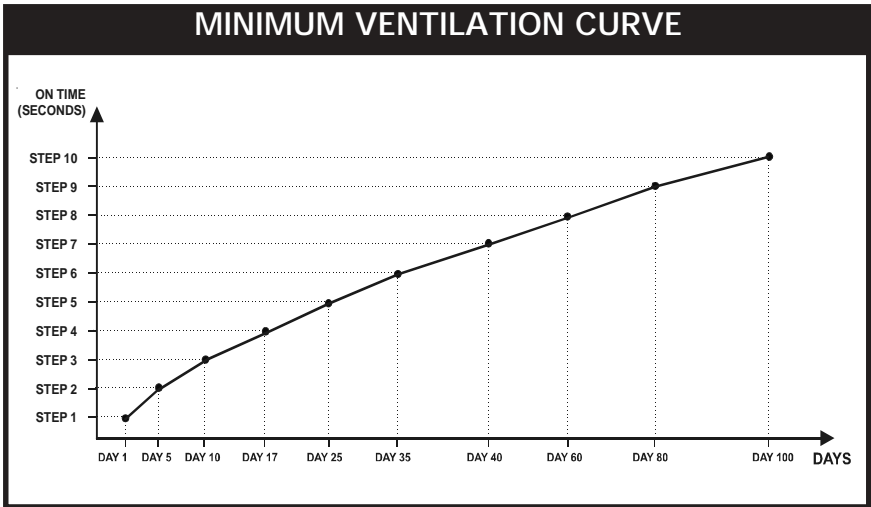

NOTES:

i) All ten points of the curve must be specified. If ten points are not needed, repeat the last On-Time value for each unnecessary point.

ii) Certain restrictions apply to reduce the risk of errors:

- The highest possible day number is 450.
- Decreasing day numbers are not allowed.
- Decreasing On-Times are not allowed.



Note that the minimum ventilation curve must be turned off to adjust its points and days. Use the down-arrow key to scroll each point of the curve. Then the curve status then flashes on the display. Use the adjustment buttons to turn it Off.

- Set the function to "7.Min Ventilation" from the main menu then press the right-arrow key.
- Use the adjustment buttons to select the "1.On Time/ Curve" menu. The current On-Time and the curve status are displayed.

- Press the down-arrow key once. The first day that corresponds to the first point of the curve, flashes on the display.

Min ventilation	▲▼
Day:	1days
On Time:	15sec

- Use the adjustment buttons to set the first day to the desired value.
- Press the down-arrow key once again. The On-Time for the first point is displayed.
- Use the adjustment buttons to adjust the On-Time to the desired value.
- Press the down-arrow key to display and adjust all other points of the curve.

- Once they are all properly set, press the down-arrow key. The curve state flashes on the display. Press \oplus to activate the curve.

Min ventilation	▲▼
Curve stat	On

NOTE: All ten points of the curve must be specified. If you don't need ten different points, repeat the last On-Time for each unnecessary point of the curve.

5.15.3 Humidity Control

If a humidity sensor is being used, the PP-32 has three mechanisms to compensate for a high humidity level :

1. The humidity level can be decreased by increasing the fans' on time during minimum ventilation cycles. Set Dipswitch #7 to ON to activate this function;
2. Kool-Cels are shut off whenever the relative humidity is too high (this applies to fan stage outputs that are using a timer relay). Set Dipswitch #5 to ON to activate this function ;
3. Heaters are activated in timer mode whenever the relative humidity is too high. Set Dipswitch #6 to ON to activate this function;

5.15.3.1 Adjusting Relative Humidity Set Point

- Set the function to "**18.RH Compensation**" from the main menu using the navigation buttons then press the right-arrow key. Note that this menu only appears if the relative humidity sensor has been enabled during the installation setup (see sec. 5.14.3).
- Use the navigation buttons to select the relative humidity set point (*RH Set Point*) display.
- Use the adjustment buttons to adjust the relative humidity set point to the desired value.

RH Compensation	▲▼
Add Min Vent sec	60
RH set point %	65
Mist shutoff %	Off

5.15.3.2 RH Compensation on Minimum Ventilation

When the humidity level reaches the RH set point + 10%, the On-Time portion of the minimum ventilation cycle is increased by an amount ranging from 0 to 900 seconds. Set the dipswitch #7 to ON to activate this function.

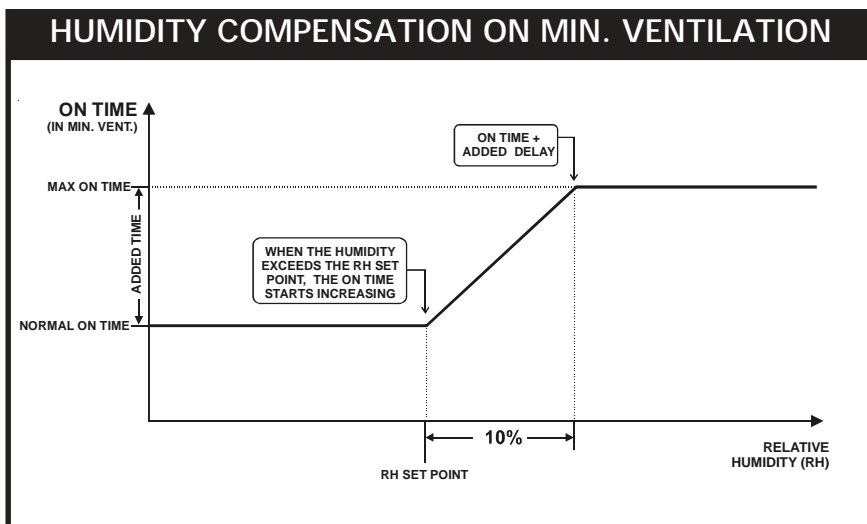

- Set the function to "**18.RH Compensation**" from the main menu using the navigation buttons then press the right-arrow key. Note that this menu only appears if the relative humidity sensor has been enabled during the installation setup (see sec. 5.14.3).
- Use the adjustment buttons to set the time that will be added to the minimum ventilation's On-Time when the humidity level reaches the Humidity Set Point + 10% (*Add Min Vent sec*).

RH Compensation	▲▼
Add Min Vent sec	30
RH set point %	65
Mist shutoff %	Off

5.15.3.3 Adjusting Mist or Kool-Cel Shutoff

When the humidity level is too high, Kool-Cel or mist units are shut off to avoid increasing the humidity level any further. This means that the fan stage outputs that operates in timer mode stop operating whenever the humidity level exceeds the mist shutoff limit. This limit ranges from 25% to 100% (Off) of humidity. Set the dipswitch #5 to ON to activate this function.

- Set the function to "18.RH Compensation" from the main menu using the navigation buttons then press the right-arrow key. Note that this menu only appears if the relative humidity sensor has been enabled during the installation setup (see sec. 5.14.3).
- Use the navigation buttons in order to select the "Mist Shutoff" display.
- Use the adjustment buttons to set the mist shutoff humidity level to the desired value.

RH Compensation	▲▼
Add Min Vent	30
RH set point %	65
Mist shutoff %	90

5.15.3.4 RH Compensation on Heaters' On-Time

Heaters can be activated in timer mode to compensate for a high level of humidity. As the humidity level increases, the heaters' On-Time increases proportionally to compensate for the change. The heaters reach their full

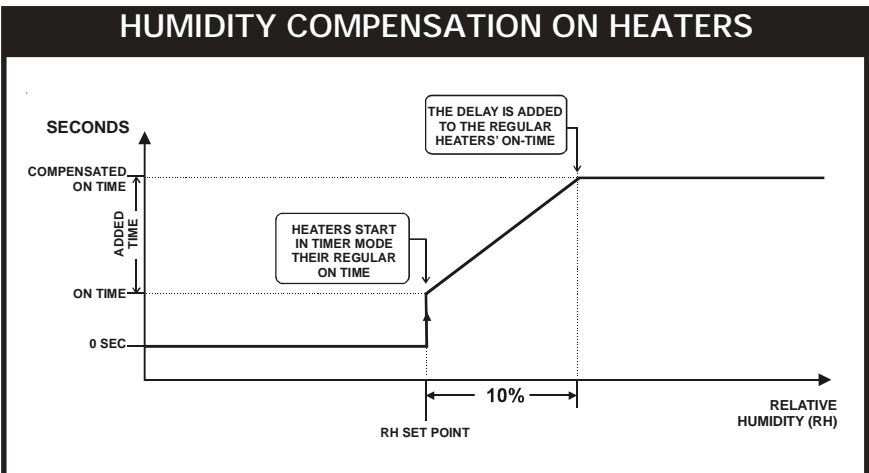

On-Time when the humidity is at or above RH Set Point + 10% as shown below. Set the dipswitch #6 to ON to use this function.

- Set the function to "**18.RH Compensation**" from the main menu using the navigation buttons then press the right-arrow key. Note that this menu only appears if the relative humidity sensor has been enabled during the installation setup (see sec. 5.14.3).
- Use the navigation buttons in order to select the "**Heater On time**" display.
- Use the adjustment buttons to set the Heater's On-Time to the desired value. This is the minimum heater's On-time when the compensation starts.
- Press the down-arrow key once to select the "**AddHeat On time**" display.
- Use the adjustment buttons to set added On-Time to the desired value.
- Press the down-arrow key once to select the "**Heater Off time**" display.
- Use the adjustment buttons to set the Heater's Off-Time to the desired value.

RH set point %	65
Mist shutoff %	Off
Heater On time	15
AddHeat On time	30
Heater Off time	60

5.15.4 Calibrating Sensors

The reading of each sensor can be slightly adjusted by the user in order to obtain the most accurate and uniform readings of all sensors. The calibration of sensors can only be performed in the installer mode (see sec. 5.14.2).

5.15.4.1 Calibrating Room and Outside T° Sensors

The reading of each temperature sensor can be adjusted by an amount of $\pm 3^\circ\text{F}$ ($\pm 1.7^\circ\text{C}$).

- Set the function to "**3.Temp. Sensors**" from the main menu using the navigation buttons. Sensors' temperature readings are displayed.
- Use the down-arrow key to select the calibration menu of a room temperature sensor or of the outside temperature sensor (*Cal.Sens.x or Cal.Out*). Note that these menus are only displayed in the installer mode (see sec. 5.14.2).

Temperature Sensors	▲▼
Sensor 1:	72.3°F
Cal.Sens.1	0.0°F
Sensor 2:	73.0°F

- Use the adjustment buttons to set the temperature that will be added or removed from all readings of the selected sensor.

5.15.4.2 Calibrating the Relative Humidity Sensor

The reading of the humidity sensor can be adjusted by an amount of $\pm 3\%$.

- Set the function to "**4.R. Humidity**" from the main menu using the navigation buttons then press the right-arrow key. The current relative humidity level is displayed. Note that this menu is only accessible if a humidity sensor has been enabled (see sec. 5.14.3).
- Press the down-arrow key once in order to select the calibration menu of the humidity sensor "**Cal. RH**". Note that this menu is only displayed in the installer mode (see sec. 5.14.2).

Relative Humidity	▲▼
Current RH	Low %
Cal. RH	0%
Min/Max	Recorded

- Use the adjustment buttons to set the humidity level that will be added or removed from all readings of the humidity sensor.

5.15.4.3 *Calibrating the Static Pressure Level*

The reading of the static pressure level can adjusted by an amount of ± 0.030 "WC (± 7 Pa).

- Select "**8.Vents/Static P**" from the main menu using the navigation buttons then press the right-arrow key. The calibration menu flashes on the display "**Cal. SP**". Note that this menu is only available if the static pressure sensor has been enabled during the installation setup and in the installer mode (see sec. 5.14.2 and 5.14.3).

Vents/Static Press	◆
Cal. SP	.000"WC
Close At:	.070"WC
Open At:	.090"WC
- Use the adjustment buttons to set the humidity level that will be added or removed from all readings of the humidity sensor.

5.15.5 Test Mode

A test mode allows you to simulate temperature changes and verify the controller's performance. In test mode, the temperature sensor inputs are turned off, allowing the user to change the temperature used by the controller to operate the stages. The controller operates as before using the new temperature settings.



Adjusting Room Temperature

When the room temperature is adjusted, the controller bypasses the temperature sensor inputs and uses the new value as a reference. The test mode is deactivated after 15 minutes of inactivity.

- Set the function to "23.Test Mode" from the main menu using the navigation buttons then press the right-arrow key. The On/Off status of the test mode displayed.
- Press  to activate the test mode.
- Press the down-arrow key to select the room temperature.
- Use the adjustment buttons to set the room temperature to the desired value.
- The controller then displays the fan stage that is activated, in accordance with the selected temperature. It also displays the current program in use and the static pressure readings (if a static pressure sensor is used). These values are displayed as readings, they cannot be modified.

Test Mode	On	▲
Mode	On	▼
Temp:	69.5 °F	
Static Pressure	.015	
Fan Stage:	Min.V	
Program:	(a)	

6. TECHNICAL SPECIFICATIONS

Type	PP-32
Controller's supply fuse F1	 1A, fast-blow
Relays' supply fuse F1	 3A, fast-blow
Mains supply/frequency	230 Vac , 50/60Hz
14Vdc output	14 Vdc \pm 10%, regulated, 200mA max.
14Vdc output fuse F2	 1A max, fast-blow
Relays' Maximum load ratings:	
Max voltage :	270Vac or 30 Vdc
Max motor load:	1HP at 120 Vac, 2HP at 240Vac
Max resistive load current:	15 A
Alarm contact:	10mA to 2A, 24 Vac or dc max.
Housing	NEMA 4X, IP54, plastic casing, IEC 529, UL-508-4X
Operating temperature	32 to 140° F (0 to 40° C)
Storage temperature	5 to 104° F (-15 to 50° C)
Ambient relative humidity	max. 95%

The room temperature where the controller is located **MUST ALWAYS REMAIN BETWEEN 32° AND 104°F (0° AND 40°C).**

7. FACTORY SETTINGS



PARAMETER		FACTORY SETTING	RANGE OF VALUES
Temperature Set Point		80.0°F (26.7°C)	32 to 120°F (0 to 48.9°C)
Animal Age		OFF	1 to 450 days
Minimum Ventilation	On Time	30sec	0 to 900s
	Cycle Time	300sec	0 to 900s
Tunnel Ventilation	First Tunnel Stage	5	3-16
	Minimum Age	0	1 to 450 days
	Curtain Open/Close Times	30sec	0 to 15 minutes, in increments of 5 seconds
	Total Run Time	2min	0 to 15 minutes, in increments of 5 seconds
	Pre Open Tunnel Delay	30sec	0 to 30seconds
Vent Doors	High Pressure Set Point (Open At)	0.080"WC (19.5Pa)	0.005 to 0.200"WC (1.3 to 49.8Pa)
	Low Pressure Set Point (Close At)	0.050"WC (12.5Pa)	0 to 0.200"WC (0 to 49.8Pa)
	Opening Time	60sec	0 to 900seconds
	Closing Time	60sec	0 to 900seconds
	Off Time	10sec	0 to 900seconds
	Pre Open Vent Delay	10sec	0 to 60seconds
	Stage Level for Closing Vent Doors	None	First Tunnel Stage to Fan stage number
Alarms	High Alarm Temperature	15.0°F (8.3°C)	0.5 to 35°F (0.3 to 19.4°C) above the set point
	Low Alarm Temperature	10.0°F (5.6°C)	0.5 to 20°F (0.3 to 11.1°C) below the set point
	Critical Temperature	95°F (35°C)	0.5°F(0.3°C) above the set point to 120°F (48.9°C)
	High Pressure Alarm	0.150"WC (37.4Pa)	0 to 0.400"WC (0 to 100Pa)
	Low Pressure Alarm	0.015"WC (3.7Pa)	0 to 0.395"WC (0 to 98.5Pa)
	Program Selection	Season	Summer
# of programs		1	1 to 4

8. USING THE MEMORY STICK

8.1 Load a Configuration into the Controller

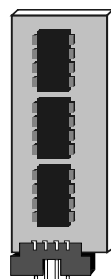

- 1- Position the memory stick on the J1 connector located at the upper left corner of the board, with the components facing DOWN.





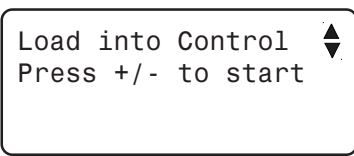

- 2- Simultaneously press the up and down-arrow keys   during a 5 second delay. The following message is displayed :

"Load into Control, Press +/- to start"





Load into Control 
Press +/- to start 

- 3- Simultaneously press the + and - push buttons  . The configuration starts to load into the controller. Wait until it is completely loaded.
- 4- Once the transfer has reached 100%, simultaneously press on the up and down-arrow keys   once again to exit this menu.
- 5- The new configuration is now loaded into the controller. Remove the memory stick from the connector.

8.2 Save a Configuration into the Memory Stick

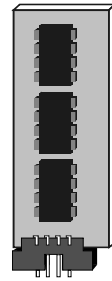
- 1- Place the memory stick on the J1 connector, at the upper left corner of the board, with the components facing DOWN.



- 2- Simultaneously press the up and down-arrow keys   during a 5 second delay. The following message is displayed :

“ Load into control. Press +/- to start”

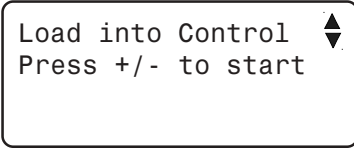



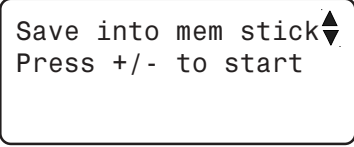

Load into Control 
Press +/- to start

- 3- Press the up-arrow key once. The following message is then displayed:

“ Save into mem stick. Press +/- to start”



Save into mem stick 
Press +/- to start

- 4- Simultaneously press the + and - push buttons  . The configuration starts being saved on the memory stick. Wait until it is completely saved.
- 5- Once the transfer has reached 100%, press the up and down-arrow keys   once again to exit this menu.
- 6- The new configuration is now saved into the memory stick. Remove the memory stick from the connector.

9. INSTALLATION REPORT

CONTACT INFORMATION

CLIENT INFORMATION

NAME:

ADDRESS:

CITY:

TEL.:

FAX:

INSTALLER INFORMATION

NAME:

ADDRESS:

CITY:

TEL.:

FAX:

SENSOR ASSIGNMENT TEMPLATE (see sec. 5.14.4)

Note : each program (a, b, c and d) has its own sensor assignment for the average room temperature

SENSOR ASSIGNMENT		
OUTPUTS	DESCRIPTION	SENSORS
Room T° (a)	_____	1□ 2□ 3□ 4□ 5□ 6□ 7□ 8□
Room T° (b)	_____	1□ 2□ 3□ 4□ 5□ 6□ 7□ 8□
Room T° (c)	_____	1□ 2□ 3□ 4□ 5□ 6□ 7□ 8□
Room T° (d)	_____	1□ 2□ 3□ 4□ 5□ 6□ 7□ 8□
Heater 1	_____	1□ 2□ 3□ 4□ 5□ 6□ 7□ 8□
Heater 2	_____	1□ 2□ 3□ 4□ 5□ 6□ 7□ 8□
Heater 3	_____	1□ 2□ 3□ 4□ 5□ 6□ 7□ 8□
Heater 4	_____	1□ 2□ 3□ 4□ 5□ 6□ 7□ 8□
Heater 5	_____	1□ 2□ 3□ 4□ 5□ 6□ 7□ 8□
Heater 6	_____	1□ 2□ 3□ 4□ 5□ 6□ 7□ 8□
Heater 7	_____	1□ 2□ 3□ 4□ 5□ 6□ 7□ 8□
Heater 8	_____	1□ 2□ 3□ 4□ 5□ 6□ 7□ 8□
Auxiliary 1	_____	1□ 2□ 3□ 4□ 5□ 6□ 7□ 8□
Auxiliary 2	_____	1□ 2□ 3□ 4□ 5□ 6□ 7□ 8□
Inlet 1	_____	1□ 2□ 3□ 4□ 5□ 6□ 7□ 8□
Inlet 2	_____	1□ 2□ 3□ 4□ 5□ 6□ 7□ 8□
Inlet 3	_____	1□ 2□ 3□ 4□ 5□ 6□ 7□ 8□
Inlet 4	_____	1□ 2□ 3□ 4□ 5□ 6□ 7□ 8□
Inlet 5	_____	1□ 2□ 3□ 4□ 5□ 6□ 7□ 8□
Inlet 6	_____	1□ 2□ 3□ 4□ 5□ 6□ 7□ 8□
Inlet 7	_____	1□ 2□ 3□ 4□ 5□ 6□ 7□ 8□
Inlet 8	_____	1□ 2□ 3□ 4□ 5□ 6□ 7□ 8□
Inlet 9	_____	1□ 2□ 3□ 4□ 5□ 6□ 7□ 8□
Inlet 10	_____	1□ 2□ 3□ 4□ 5□ 6□ 7□ 8□
Inlet 11	_____	1□ 2□ 3□ 4□ 5□ 6□ 7□ 8□
Inlet 12	_____	1□ 2□ 3□ 4□ 5□ 6□ 7□ 8□

INSTALLATION SETUP TEMPLATE (see sec. 5.14.3)

INSTALLATION SETUP	
Parameter	Setting
Reset Min/Max	_____ : _____
Relative humidity sensor	<input type="checkbox"/> YES <input type="checkbox"/> NO
Pre-Open vents delay	_____ (0 to 60 sec.)
Pre-Open tunnel delay	_____ (0 to 30 sec.)
Use Tunnel ?	<input type="checkbox"/> YES <input type="checkbox"/> NO
Tunnel Mode	<input type="checkbox"/> TIMER <input type="checkbox"/> STATIC P.
Use static pressure sensor?	<input type="checkbox"/> YES <input type="checkbox"/> NO
Static Set. 2	<input type="checkbox"/> STAGE <input type="checkbox"/> OUTSIDE T° <input type="checkbox"/> NONE
Number of air inlets	_____ (0 to 12)
Number of auxiliary outputs	<input type="checkbox"/> 1 <input type="checkbox"/> 2
Auxiliary output 1 Mode	<input type="checkbox"/> HEATING <input type="checkbox"/> COOLING
Auxiliary output 2 Mode	<input type="checkbox"/> HEATING <input type="checkbox"/> COOLING
Number of fan stages	_____ (2 to 16)
Number of stage programs	<input type="checkbox"/> NONE <input type="checkbox"/> ab <input type="checkbox"/> abc <input type="checkbox"/> abcd
Number of heater stages	_____ (0 to 8)
Number of clocks	_____ (0 to 4)
# of programs for clock 1	_____ (1 to 8)
# of programs for clock 2	_____ (1 to 8)
Number of sensors	_____ (1 to 8)
Use outside temperature?	<input type="checkbox"/> YES <input type="checkbox"/> NO OUTSIDE T° INFLUENCE _____ °F ON ALARMS
Contrast	_____ (0 to 100%)
Installer password code	--- --- ---

PP-32

RELAY ASSIGNMENT TEMPLATE (see sec. 5.14.6)

PROCEDURE

- 1- Write down the description of each relay.
- 2- Put an "X" to assign ON/OFF relays or a "T" for relays that operate in timer mode.

RELAY ASSIGNMENT EXAMPLE

OUTPUT/ RELAY #	<i>Kool-Cel</i>	<i>Exhaust Fan 1</i>	<i>Exhaust Fan 2</i>	<i>Exhaust Fan 3</i>
Cooling Stage 1		X	X	
Cooling Stage 2		X	X	X
Cooling Stage 3	T	X	X	X

In minimum vent. : Exhaust Fans 1 and 2 operates according to the minimum ventilation timer (minimum ventilation cycles run stage 1 fans in timer mode).

At cooling stage 1 : Exhaust Fans 1 and 2 run continuously;

At cooling stage 2: Exhaust Fans 1, 2 and 3 run continuously.

At cooling stage 3: Exhaust Fans 1, 2 and 3 run continuously and the Kool-Cel is activated in timer mode.



Each controller program uses a separate relay assignment for cooling stages 1 to 4 (program a, b, c or d).

10. INDEX

A

Age see Animal age

Air inlets see inlets

Alarms

- Alarm connection 12
- Alarm limits 53–58
- Alarm log 52
 - Resetting the alarm log 48, 58, 63
- Clock program alarm 45
- Critical temperature alarms 53
- Static pressure alarms 56
 - Assigning relays for Lo SP alarm 76
 - Deactivating LO pressure alarm 56
- Temperature alarms 54
 - Critical temperature alarm 55
 - Outside influence on T° alarms 55

Animal age

- Minimum age before tunnel ventilation 34
- Setting the animal age 44

Arrow keys 10

Assignment of relays see relays

Assignment of sensors see Sensors

Auxiliary outputs

- Activating auxiliary outputs 64
- Adjusting auxiliary output settings 42–43
- Assigning relays to auxiliary outputs 75
- Assigning sensors to auxiliary outputs 68–69

Average temperature see Temperature

B

Buttons 10

C

Calibration

- Calibrating the water counter 77
- Sensors' calibration 86–87

Celsius degrees 14

Clock

- Selecting time units 14
- Setting time and date 70

Clock outputs

- Activating clock outputs 65
- Activating clock programs 65
- Adjusting clock output settings 45–47
- Assigning relays to clock outputs 75

Compensation

- Air inlet compensation 22
- Humidity compensation 82–85

Configuration module 91–92

Connections 11

- Alarm connection 12
- Precautions 6
- Technical specifications 89

Controller

- Connections 11
- Factory settings 90
- Front panel 9
- Installation setup 63
- Location of the controls 9
- Main features 7
- Model number 6
- Mounting instructions 11
- Serial number 6

Step-by-step installation 59–60

Technical specifications 89

Critical temperature see Temperature

Curtains see Tunnel ventilation

Curves

- Minimum ventilation curve
 - Adjusting the minimum ventilation curve 80
 - Deactivating the min. vent. curve 19
- Temperature curve
 - Adjusting the temperature curve 78
 - Deactivating the temperature curve 18

D

Date

Setting time and date 70

Dip switches 14

Display

- LCD display 10
- LED display 10

DWR-F-1A see also Inlets

- Activating air inlets 64
- Setting DWR-F-1A's ID numbers 13, 21

E

Electrical specifications 89

Endwall ventilation see Tunnel ventilation

F

Factory settings 90

Fahrenheit degrees 14

Fans

- Fan stages
 - Activating fan stages 64
 - Adjusting fan stages 38–40
 - Assigning relays to fan stages 72
 - Assigning sensors to fan stages 66
 - Timer relay on fan stages 39, 72
- Fans' On-Time in minimum ventilation 15

G

Gallon units 14

H

Heaters

- Activating heater stages 64
- Assigning relays to heater stages 73
- Assigning sensors to heater stages 67
- Heater stages' settings 41
- History of heater run times 50–51
- R. humidity compensation using heaters 84

History 48–51

Clearing histories 44, 46, 48

Hot keys 10

Humidity see Relative humidity

I

Identification numbers 13, 21

Inches of water units 14

Inlets

- Activating air inlets 64
- Adjusting inlet settings 21–22

- Assigning sensors to air inlets 67
- Inlet compensation 22
- Inlets' operation 21
- Installation
 - Installation report templates 93–96
 - Installation setup 63–65
 - Installation setup template 95
 - Step by step installation 59–60
- Installer password 61

K

Keys see also buttons

- Shortcut keys 10

Kool-Cel pump

- Adjusting Kool-Cel timer 39
- Assigning Kool-Cel relays 72
- Kool-Cel shutoff 84

L

LCD display 10

Led display 10

Limits

- Alarm limits see also Alarms 53–58

Litre units 14

Loading a configuration 91

Logs see History

M

Memory Stick 91–92

Minimum ventilation

- Adjusting minimum ventilation's settings 19–20
- Fans' On-Time in minimum ventilation 15
- Minimum ventilation curve 80
- Relative humidity compensation on min. vent 83

Mist

- Adjusting mist timer 39
- Assigning mist relays 72
- Mist shutoff 84

Modules

- Air inlet modules see also DWR-F-1A 13

Mounting instructions 11

N

Navigation buttons 10

O

Options

- Installation options 63–65

Outside Temperature see Temperature

P

Parameters

- Adjusting a parameter 10

Pascal units 14

Password

- Changing the installer's password 62
- Password settings 61–62

Potentiometer control see DWR-F-1A

Pre-opening the tunnel see Tunnel ventilation

Pre-opening vents see Vent doors

Pressure units 14

Probes see also Sensors

Programs

- Activating programs 64
- Clock programs 45, 65
- Program selection 16
- Season selection 16
- Viewing the program currently in use 15

Pump see Kool-Cel pump

R

Ramping see Curves

Relative humidity

- Activating the relative humidity sensor 63
- Calibrating the relative humidity sensor 86
- History of humidity readings 49
- Humidity set point 82
- Relative humidity compensation 82–85
- Viewing the current humidity level 15

Relays

- Relay assignment 70–76
 - Relay assignment template 96
- Timer relays on fan stages 39, 72

Report 93–96

Reset

- Reset time 63
- Resetting histories 48
- Resetting the alarm log 58

RH see Relative humidity

Room temperature see temperature 66

S

Saving a configuration 92

Seasons

- Selecting a season 16

Sensors

- Activating temperature sensors 65
- Calibrating sensors 86–87
- Connecting sensors 11
- Current sensor readings 15
- Extending a sensor 12
- Identify a defective sensor 12
- Outside T° sensor see Temperature
- Relative humidity sensor see Relative humidity
- Sensor assignment 66–69
 - Sensor assignment template 94
- Sensor inputs 11
- Static pressure sensor see Static pressure 15

Serial number 6

Set points

- Relative humidity set point 82
- Room set point
 - Adjusting the room set point 18
 - Viewing current room set point 15
- Static pressure set points for tunnel curtains 36
- Static pressure set points for vent doors 26
 - Groups of static pressure set points 24, 25, 28–30, 64

Settings

- Adjusting a parameter 10
- Adjusting set points see Set points
- Alarm limits 53–58
- Animal age adjustment 44

- Clock output settings 45–47
 - Factory settings 90
 - Fan stages settings 38
 - Heater settings 41
 - Humidity compensation 82–85
 - Inlet settings 21–22
 - Minimum ventilation settings 19–20
 - Password settings 61–62
 - Relay assignment 70–76
 - Sensor assignment settings 66–69
 - Time & date settings 70
 - Tunnel ventilation settings 31–37
 - Vent doors settings 23–30
- Setup**
- Installation setup 63–65
 - Step by step installation 59–60
- Sidewall ventilation** see Vent doors or Inlets
- Static pressure**
- Activating the static pressure sensor 64
 - Calibrating the static pressure sensor 87
 - Static pressure alarms 56–58
 - Assigning relays for lo SP alarm 76
 - Static pressure Hi and Lo alarm limits 33, 56
 - Static pressure for tunnel curtains
 - Activating tunnel curtains in SP mode 63
 - Static pressure set points 36
 - Static pressure for vent doors
 - Groups of static pressure set points 24, 25, 28–30
 - Static pressure set points 26
 - Static pressure units 14
 - Viewing the current static pressure level 15
- Stick** see Memory stick
- Summer** see Seasons
- T**
- Table of contents** 3
- Tables** see Templates
- Technical specifications** 89
- Temperature**
- Activating temperature sensors 65
 - Average room temperature 15
 - Adjusting the temperature in test mode 88
 - Assigning sensors to the Room T° 66
 - Critical temperature 53, 55
 - History
 - History of the average temperature 48
 - History of the outside temperature 49
 - Outside temperature
 - Activating outside temperature sensor 65
 - Calibrating the outside temperature sensor 86
 - Outside influence on temperature alarms 53
 - Pressure set points influenced by out. T° 25
 - Viewing current outside temperature 15
 - Temperature alarms see Alarms
 - Temperature curve 78
 - Temperature set point see Set points
 - Temperature units 14
- Temperature units** 14
- Templates** 93–96
- Installation setup template 95
 - Relay assignment template 96
 - Sensor assignment template 94
- Test mode** 88
- Time**
- Reset time 63
 - Setting time and date 70
 - Setting time units 14
- Timer**
- Minimum ventilation timer 20
 - Timer relays on fan stages 39, 72
 - Tunnel curtain timer 36
 - Vent doors timer 26
- Tunnel curtain** see Tunnel ventilation
- Tunnel ventilation** 31–37
- Activating the tunnel curtain 63
 - Assigning relays to the tunnel curtain 74
 - Curtain controlled by static pressure 31
 - Pre-opening delay 32, 63
 - Selecting tunnel mode : SP/Timer 63
 - Tunnel and sidewall transition 33
 - Tunnel curtain controlled by static pressure 32
 - Tunnel curtain in timer mode 31
- U**
- Units**
- Unit selection 14
- User password** 61
- User setup** see Installation setup
- V**
- Vent doors**
- Adjusting vent door settings 23–30
 - Assigning relays to vent doors 73
 - Pre-opening delay 19, 20, 63
 - Tunnel and sidewall transition 33
 - Vent doors' operation 21
- Ventilation**
- Endwall ventilation see Tunnel ventilation
 - Sidewall ventilation see Inlets or Vent doors
- W**
- Water**
- Calibrating the water counter 77
 - History of the water consumption 50
 - Water unit selection 14
- Weather** see Temperature
- Winter** see Seasons
- Wiring** 11